

2015 A

gültig ab:
valid from:
valable dès:
validità dal:
1. 7. 2015

RatioTap®

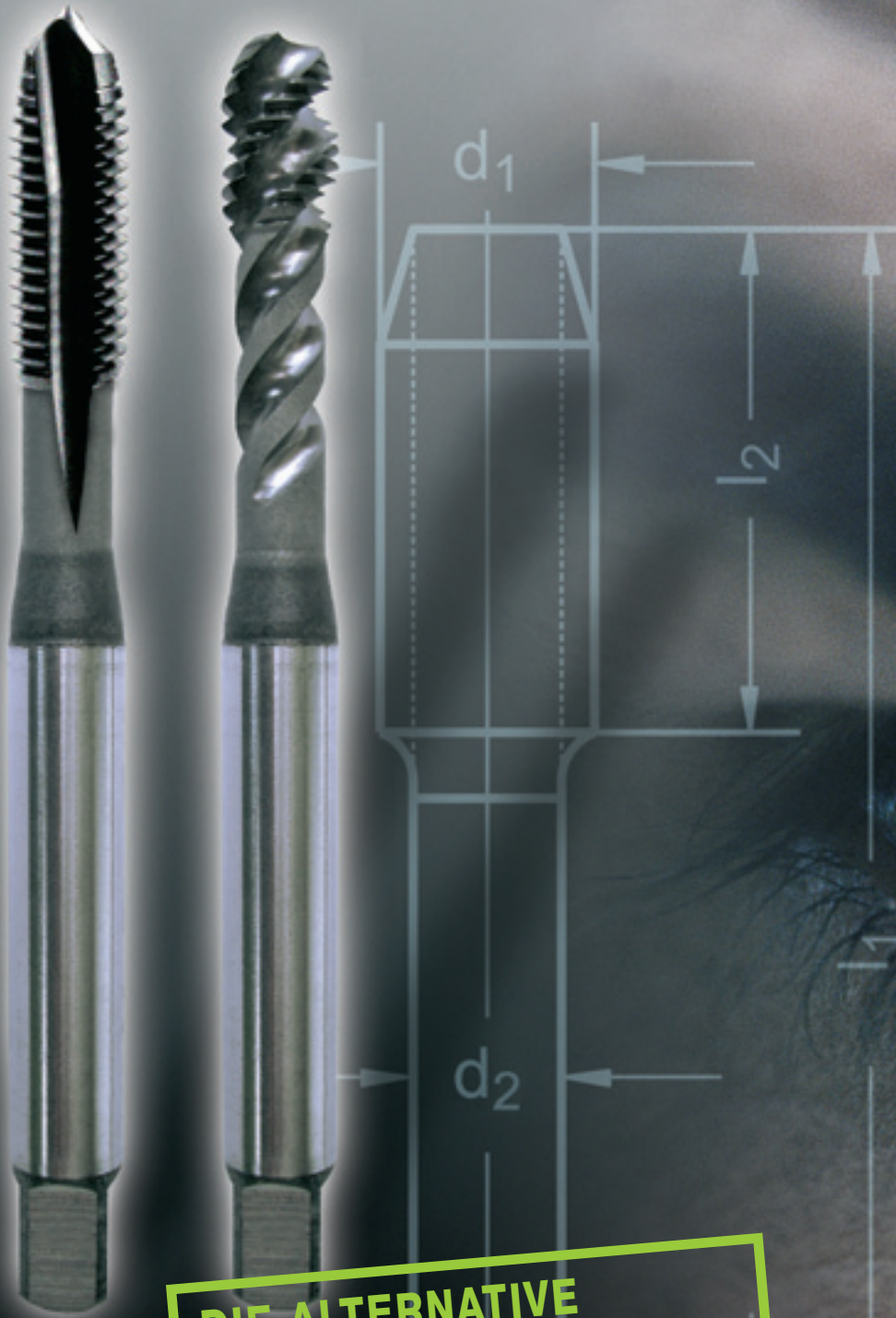

DIE ALTERNATIVE
The alternative
L'alternative
L'alternativa

RatioLine®

 **Ihr Vorteil:**
RatioLine®

Mit der neuen Marketingstrategie **RatioLine®** konnten wir bei WEXO® die drei wichtigsten Forderungen unserer Kunden in idealer Weise vereinen.

Preis:

Die Fertigung ausgewählter und bewährter Werkzeuge in großen Stückzahlen, auf hochmodernen Präzisions-Schleifmaschinen, führt zu einer deutlichen Steigerung der Produktivität. Der mit der Produktivitätssteigerung verbundene Preisvorteil wird in vollem Umfang an die Kunden der neuen **RatioLine®** weitergegeben.

Qualität:

Durch den Einsatz ausgewählter Schneidstoffe mit auf die Anwendung hin optimierter Oberflächenveredelungen, die Fertigung auf hochmodernen Präzisions-Schleifmaschinen und durchgängigen Kontrollmechanismen ist die neue **RatioLine®** ein Beweis für gelebte Qualität **Made by WEXO®**.

Verfügbarkeit:

Ein Höchstmaß an Verfügbarkeit wird durch die Fertigung großer Lose unserer **RatioLine®**-Werkzeuge erreicht. Prüfen Sie uns! Bestellen Sie noch heute per Telefon, Fax oder E-Mail und Sie können schon morgen mit den Werkzeugen der **RatioLine®** Ihre Fertigung rationalisieren.

 **Your benefit:**
RatioLine®

Our new marketing strategy **RatioLine®** has enabled us to unify our customers' three key purchasing criteria.

Price:

The production of tools in large quantities using state-of-the-art precision grinding

machines has greatly increased our productivity, a benefit we are passing on to our customers' manufacturing processes in the form of competitive pricing.

Quality:

The use of selected cutting material with an application-specific surface finish, the production using state-of-the-art grinding machines, and end-to-end total quality control, demonstrate that **RatioLine®** is quality **Made by WEXO®**.

Availability:

Availability is guaranteed by manufacturing in large batches, thereby maximising flexibility for our customers. Try WEXO® today and order by telephone, fax or email and tomorrow you will be in a position to rationalise your manufacturing processes using **RatioLine®** tools.

 **Vos avantages:**
RatioLine®

Avec la nouvelle stratégie de marketing, WEXO® a pu unir 3 exigences de notre clientèle.

Prix:

La production de masse sur des machines ultramodernes et précises permet une nette amélioration de la productivité. Vous profitez complètement de cet avantage de prix obtenu grâce à ces critères.

Qualité:

En utilisant des matières premières spécifiques et des revêtements optimisés, des machines ultramodernes et des mécanismes de contrôle permanents, la nouvelle **RatioLine®** prouve la qualité connue **Made by WEXO®**.

Disponibilité:

Nous vous garantissons un maximum de disponibilité grâce à nos lots de production

importants de notre gamme **RatioLine®**. Passez encore aujourd'hui votre commande soit par téléphone, fax ou courrier électronique et dès demain vous rationalisez votre production avec nos outils de la **RatioLine®**.

 **Il Vostro Vantaggio:**
RatioLine®

La nostra nuova strategia di marketing **RatioLine®** consente ai ns. clienti di unificare tre criteri di acquisto.

Prezzo:

la produzione di utensili in grandi quantità, utilizzando rettifiche moderne, ha notevolmente incrementato la produttività e questo vantaggio noi lo passiamo ai nostri clienti sotto forma di prezzo competitivo.

Qualità:

L'uso di materiali da taglio selezionati con finiture superficiali specifiche, macchine moderne e un controllo minuzioso, ci fanno affermare che la **RatioLine®** è qualità **MADE by WEXO®**.

Diponibilita':





















La disponibilita' è garantita dal fatto che gli utensili vengono prodotti in grandi lotti e consentono ai nostri clienti la massima flessibilita'. Prova WEXO® oggi, ordina al telefono, via fax o via e-mail ai nostri rivenditori e domani ti renderai conto di come potrai razionalizzare i tuoi processi produttivi utilizzando gli utensili **RatioLine®**.

Allgemeine Geschäftsbedingungen
General sales conditions
Conditions générales de vente
Condizioni generali di vendita:
<http://www.wexo.com>



Inhaltsverzeichnis · Table of Contents · Sommaire · Indice





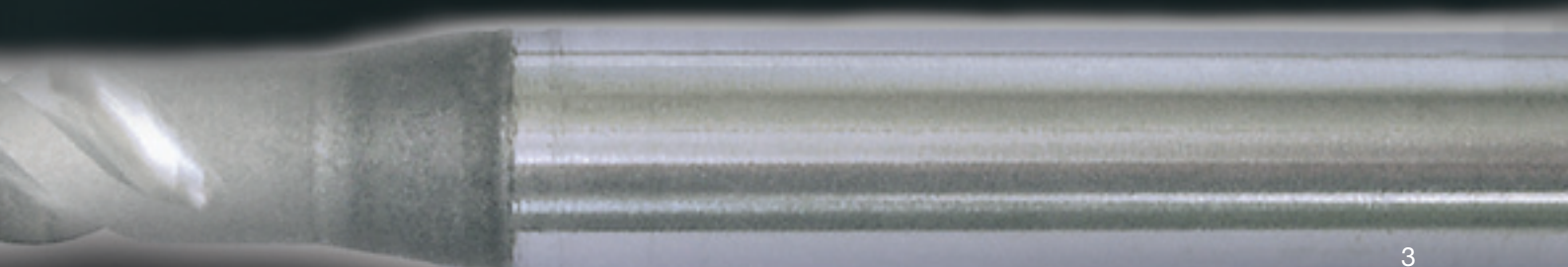

















Übersicht Maschinengewindebohrer / Schnittwertempfehlung Overview of taps / Recommended cutting data Aperçu de tarauds / Paramètres de coupe Programma maschi a macchina / Parametri di taglio consigliati		6						
M	Typ N	ISO2 6H	HSSE	DIN 352	M 3 – M12		10	
								
								
M	Typ N	ISO2 6H	HSSE	DIN 371	M 3 – M10	DIN 376	M12 – M30	10
								
M	Typ N	ISO2 6H	HSSE	DIN 371	M 3 – M10	DIN 376	M12 – M30	11
								
								
								
								
M	Typ VA	ISO2 6H	HSSE	DIN 371	M 3 – M10	DIN 376	M12 – M30	12
								
								
								
								











Inhaltsverzeichnis · Table of Contents · Sommaire · Indice







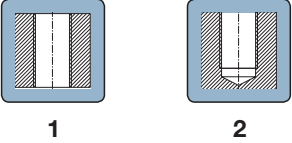

M	Typ GG	6HX	HSSE	DIN 371	M 3 – M10	DIN 376	M12 – M30	13	
									
M	Typ AL	ISO2 6H	HSSE	DIN 371	M 3 – M10	DIN 376	M12 – M20	14	
 									
M	Typ H	ISO2 6H	HSSE-PM	HSSE	DIN 371	M 3 – M10	DIN 376	M12 – M30	15
       									
M	Typ UNI	6HX	HSSE	DIN 2174	M 3 – M16				16
     									
MF	Typ N	Typ VA	ISO2 6H	HSSE	DIN 374	M 4 x 0,5 – M20 x 1,5			17
   									

Inhaltsverzeichnis · Table of Contents · Sommaire · Indice
 

G	Typ N	Typ VA	HSSE	DIN 5156	G1/8" - G2"	18	
 NB00-G		 VAB00VP-G		 NC40-G		 VAC40VP-G	
UNC	Typ N	2B	HSSE	DIN 2184-1	Nr. 8-32 - 1"-8	19	
 NB00-UNC		 NC40-UNC					
UNF	Typ N	2B	HSSE	DIN 2184-1	Nr. 10-32 - 1"-12	20	
 NB00-UNF		 NC40-UNF					
Gewindebohrerkassetten mit Kernlochbohrern Tap cases with drills Coffrets de tarauds avec forets d'avant trou Cassette di Maschi con relative Punta per prefori						21	
							
Werkstoffübersicht nach Werkstoffnummer Work material overview according material-no. Index-Groupe de matières selon numéro Materiali da lavorare secondo nr. materiale						22	
Werkstoffgruppen Classification of work materials Groupes de matières Gruppi materiali						24	
Kurzzeichenerklärung Explanation of symbols Explication des symboles Spiegazione dei simboli						30	
Allgemeine Geschäftsbedingungen General sales conditions Conditions générales de vente Condizioni generali di vendita						31	

Übersicht Maschinengewindebohrer / Schnittwertempfehlung [m/min]
Overview of taps / Recommended cutting data [m/min]
Aperçu de tarauds / Paramètres de coupe [m/min]
Programma maschi a macchina / Parametri di taglio consigliati [m/min]

optimal · recommended use · bien approprié · ottimale 8 ~ 12 geeignet · suitable · approprié · adatto 8 ~ 12				DIN 352	DIN 371	DIN 374	DIN 376	DIN 2184-1	DIN 5156						
															
Katalog-Nr.	No. of Catalogue	No. de catalogue	Nr. di catalogo	NB00/NC00	NC15/NC40	NB00VP	NC40VP	NB00TI	NC40TI	NB00TC	NC40TC				
Schneidstoff	Tap Material	Matière première	Materiale da taglio	HSSE	HSSE	HSSE	HSSE	HSSE	HSSE	HSSE	HSSE				
Anschnitt	Chamfer	Entrée	Imbocco	B/C	C	B	C	B	C	B	C				
Toleranz	Tolerance	Tolérance	Tolleranza	-	-	ISO 2 (6H)	ISO 2 (6H)	ISO 2 (6H)	ISO 2 (6H)	ISO 2 (6H)	ISO 2 (6H)				
Beschichtung	Coating	Revêtement	Rivestimento	-	-	VP	VP	TiN	TiN	TiCN	TiCN				
Gewindeart	Type of Thread	Typ de Filetage	Tipo di filetto	1/1+2	1+2/2	1	2	1	2	1	2				

Werkstoffgruppen Classification of work materials Groupes de matières Gruppo materiali	Katalog-Seite Catalogue-Page Page Pagina di catalogo	M	10 / 11	10 / 11	11	11	11	11	11	11	
		MF	17	17							
		G	18	18							
		UNC	19	19							
		UNF	20	20							

1 Stähle · Steels · Aciers · Acciai									
1.1 / 1.2	8 - 12	6 - 10	10 - 15	8 - 12	15 - 18	12 - 15	18 - 22	15 - 18	
1.3	8 - 10	6 - 8	10 - 12	8 - 10	12 - 15	10 - 12	15 - 18	12 - 15	
1.4.1 / 1.5.1									
1.4.2 / 1.5.2									
1.6									
2 Gusseisen · Cast iron · Fontes · Ghise									
2.1 / 2.2									
2.3 / 2.4									
3 Kupfer / Kupferlegierungen · Copper / Copper alloys · Cuivre / Alliages de cuivre · Rame / Leghe di Rame									
3.1 / 3.3	12 - 15	10 - 12							
3.2	10 - 12	8 - 10							
3.4	10 - 12	8 - 10			15 - 18	12 - 15	18 - 22	15 - 18	
3.5									
3.6									
4 Aluminium / Aluminiumlegierungen · Aluminium / Aluminium alloys · Aluminium / Alliages d'aluminium · Alluminio / Leghe di Alluminio									
4.1 / 4.2	20 - 26	18 - 22							
4.3 / 4.4	18 - 22	15 - 18			20 - 26	18 - 22	26 - 32	22 - 26	
4.5									
5 Titan / Titanlegierungen · Titanium / Titanium alloys · Titane / Alliages de titane · Titanio / Leghe di Titanio									
5.1									
5.2									
5.3									
6 Nickel / Nickellegierungen · Nickel / Nickel alloys · Nickel / Alliages de nickel · Nickel / Leghe di Nickel									
6.1	3 - 4	2 - 3			4 - 5	3 - 4	5 - 6	4 - 5	
6.2									
6.3									
7 Kunststoffe · Plastics · Plastiques · Materie plastiche									
7.1	20 - 26	18 - 22							
7.2									
7.3									

VAB00	VAC40	VAB00VP	VAC40VP	VAB00TI	VAC40TI	VAB00TC	VAC40TC	GGC00TC	ALB00	ALC45	HB00	HC40	HB00TC	HC40TC
HSSE	HSSE	HSSE	HSSE	HSSE	HSSE	HSSE	HSSE	HSSE	HSSE	HSSE	HSSE	HSSE	HSSE	HSSE
B	C	B	C	B	C	B	C	C	B	C	B	C	B	C
ISO 2 (6H)	ISO 2 (6H)	-	-	ISO 2 (6H)	ISO 2 (6H)	ISO 2 (6H)	ISO 2 (6H)	6HX	ISO 2 (6H)	ISO 2 (6H)	ISO 2 (6H)	ISO 2 (6H)	ISO 2 (6H)	ISO 2 (6H)
-	-	VP	VP	TiN	TiN	TiCN	TiCN	TiCN	-	-	-	-	TiCN	TiCN
1	2	1	2	1	2	1	2	1/2	1	2	1	2	1	2
12	12	12	12	12	12	12	12	13	14	14	15	15	15	15
		17	17											
		18	18											
8 - 12	6 - 10	10 - 15	8 - 12	15 - 18	12 - 15	18 - 22	15 - 18							
8 - 10	6 - 8	10 - 12	8 - 10	12 - 15	10 - 12	15 - 18	12 - 15							
6 - 8	5 - 6	8 - 10	6 - 8	10 - 12	8 - 10	12 - 15	10 - 12				8 - 10	6 - 8	12 - 14	8 - 10
6 - 8	5 - 6	8 - 10	6 - 8	10 - 12	8 - 10	12 - 15	10 - 12				8 - 10	6 - 8	12 - 14	8 - 10
5 - 6	4 - 5	6 - 8	5 - 6	8 - 10	6 - 8	10 - 12	8 - 10							
10 - 12	8 - 10	12 - 15	10 - 12	15 - 20	12 - 15	20 - 25	15 - 20	18 - 22			16 - 20	12 - 16	18 - 24	16 - 20
8 - 10	6 - 8	10 - 12	8 - 10	12 - 15	10 - 12	15 - 20	12 - 15	15 - 18			12 - 16	10 - 14	16 - 20	12 - 16
12 - 15	10 - 12					18 - 22	15 - 18		12 - 15	10 - 12				
10 - 12	8 - 10	12 - 15	10 - 12	15 - 18	12 - 15	18 - 22	15 - 18	15 - 18			12 - 16	10 - 14	16 - 20	12 - 16
10 - 12	8 - 10			15 - 18	12 - 15	18 - 22	15 - 18							
8 - 10	6 - 8	8 - 10	8 - 10	12 - 15	8 - 10	15 - 18	12 - 15	10 - 12			8 - 10	6 - 8	10 - 14	8 - 10
								8 - 10			6 - 8	5 - 6	8 - 10	6 - 8
20 - 26	18 - 22					26 - 32	22 - 26		20 - 26	18 - 22				
18 - 22	15 - 18			20 - 26	18 - 22	26 - 32	22 - 26							
15 - 18	12 - 15	15 - 18	12 - 15	18 - 22	15 - 18	22 - 26	18 - 22	22 - 26			16 - 20	12 - 16	18 - 24	16 - 20
3 - 4	2 - 3	3 - 4	2 - 3								3 - 4	2 - 3		
		3 - 4	2 - 3								3 - 4	2 - 3		
											2 - 3	2 - 3		
3 - 4	2 - 3	3 - 4	2 - 3	4 - 5	3 - 4	5 - 6	4 - 5							
3 - 4	2 - 3	3 - 4	2 - 3	4 - 5	3 - 4	5 - 6	4 - 5							
											2 - 3	1 - 2	3 - 4	2 - 3
20 - 26	18 - 22					26 - 32	22 - 26		20 - 26	18 - 22				
18 - 22	15 - 18	18 - 22	15 - 18	22 - 26	18 - 22	26 - 32	22 - 26	26 - 32			18 - 24	16 - 20	18 - 28	18 - 24
18 - 22	15 - 18	18 - 22	15 - 18	22 - 26	18 - 22	26 - 32	22 - 26	26 - 32			18 - 24	16 - 20	18 - 28	18 - 24

Übersicht Maschinengewindebohrer und Innengewindeformer / Schnittwertempfehlung [m/min]
Overview of taps and fluteless taps / Recommended cutting data [m/min]
Aperçu de tarauds et tarauds à refouler / Paramètres de coupe [m/min]
Programma maschi a macchina e a rullare/ Parametri di taglio consigliati [m/min]

optimal · recommended use · bien approprié · ottimale geeignet · suitable · approprié · adatto				8 ~ 12 8 ~ 12	DIN 371	DIN 376	DIN 2174												
<p>1 2</p>																			
Katalog-Nr.	No. of Catalogue	No. de catalogue	Nr. di catalogo	HB00-PM	HC15-PM	HB00TC-PM	HC15TC-PM	UC00	UC00TI	UC00TC	UC00	HSSE-PM	HSSE-PM	HSSE-PM	HSSE-PM	HSSE	HSSE	HSSE	HSSE
Schneidstoff	Tap Material	Matière première	Materiale da taglio	B	C	B	C	C	C	C	C	B	C	B	C	C	C	C	C
Anschnitt	Chamfer	Entrée	Imbocco	ISO 2 (6H)	ISO 2 (6H)	ISO 2 (6H)	ISO 2 (6H)	6HX	6HX	6HX	6HX	ISO 2 (6H)	ISO 2 (6H)	ISO 2 (6H)	ISO 2 (6H)	6HX	6HX	6HX	6HX
Toleranz	Tolerance	Tolérance	Tolleranza	-	-	TiCN	TiCN	-	TiN	TiCN	-	-	-	TiCN	TiCN	-	-	-	-
Beschichtung	Coating	Revêtement	Rivestimento	1	2	1	2	1/2	1/2	1/2	1/2	1	2	1	2	1/2	1/2	1/2	1/2
Gewindeart	Type of Thread	Typ de Filetage	Tipo di filetto																
Werkstoffgruppen Classification of work materials Groupes de matières Gruppo materiali	Katalog-Seite Catalogue-Page Page Pagina di catalogo	M	15	15	15	15	16	16	16	16									
		MF																	
		G																	
		UNC																	
		UNF																	
1 Stähle · Steels · Aciers · Acciai																			
1.1 / 1.2								12 - 22	15 - 28	18 - 35	12 -								
1.3									10 - 20	12 - 25									
1.4.1 / 1.5.1				12 - 15	10 - 12	15 - 18	12 - 15												
1.4.2 / 1.5.2				12 - 15	10 - 12	15 - 18	12 - 15												
1.6																			
2 Gusseisen · Cast iron · Fontes · Ghise																			
2.1 / 2.2				22 - 26	18 - 22	26 - 32	22 - 26												
2.3 / 2.4				18 - 22	15 - 18	22 - 26	18 - 22												
3 Kupfer / Kupferlegierungen · Copper / Copper alloys · Cuivre / Alliages de cuivre · Rame / Leghe di Rame																			
3.1 / 3.3								12 - 22	14 - 25		12 -								
3.2				18 - 22	15 - 18	22 - 26	18 - 22												
3.4																			
3.5				12 - 15	10 - 12	15 - 18	12 - 15				10 -								
3.6				10 - 12	8 - 10	12 - 15	10 - 12												
4 Aluminium / Aluminiumlegierungen · Aluminium / Aluminium alloys · Aluminium / Alliages d'aluminium · Alluminio / Leghe di Alluminio																			
4.1 / 4.2								12 - 22	18 - 30	22 - 40	12 -								
4.3 / 4.4										22 - 40									
4.5				22 - 26	18 - 22	26 - 32	22 - 26												
5 Titan / Titanlegierungen · Titanium / Titanium alloys · Titane / Alliages de titane · Titanio / Leghe di Titanio																			
5.1				5 - 6	3 - 5														
5.2				5 - 6	3 - 5														
5.3				3 - 5	2 - 4														
6 Nickel / Nickellegierungen · Nickel / Nickel alloys · Nickel / Alliages de nickel · Nickel / Leghe di Nickel																			
6.1																			
6.2																			
6.3				3 - 4	2 - 3	4 - 5	3 - 4												
7 Kunststoffe · Plastics · Plastiques · Materie plastiche																			
7.1								15 - 25	18 - 30	22 - 40	15 -								
7.2				26 - 32	22 - 26	30 - 40	26 - 32												
7.3				26 - 32	22 - 26	30 - 40	26 - 32												

IGF	IGF	IGF	IGF	IGF
SN	UC00SNTI	UC00SNTC		
E	HSSE	HSSE		
	C	C		
K	6HX	6HX		
	TiN	TiCN		
2	1 / 2	1 / 2		

	16	16

22	12 - 28	12 - 28
	10 - 20	10 - 20

22	14 - 25	
20	12 - 22	

22	18 - 30	22 - 40
		22 - 40

25	18 - 30	22 - 40

WEXO®
KOMPETENZ IN PRÄZISION

X-TOp
GEWINDEN

Die neue Kompetenz für
hochlegierte Werkstoffe

INOX
HASTELLOY
VERGÜTUNGSSTAHLE
WERKZEUGSTAHL

NEUHEIT
2015

Den Katalog X-TOp GEWINDEN können Sie anfordern unter verkauf@wexo.com

WEXO®
KOMPETENZ IN PRÄZISION

X-TOp
TARAUDAGE

La nouvelle compétence pour les matière
fortement alliées

INOX
HASTELLOY
ACIERS TRAITÉS
ACIER A OUTILS

NOUVEAUTÉ
2015

Vouz pouvez commander le catalogue X-TOp TARAUDAGE sur verkauf@wexo.com

WEXO®
KOMPETENZ IN PRÄZISION

X-TOp
FILETTATURA

La nuova tecnologia per
i materiali alto legati

INOX
HASTELLOY
ACCIAIO DA BONIFICA
ACCIAIO PER STAMPI

NOVITÀ
2015

Potete ordinare il Catalogo X-TOp FILETTATURA su verkauf@wexo.com

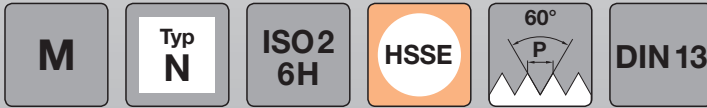

M

HSSE

DIN 352

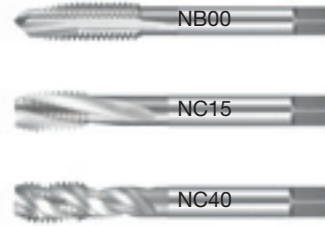
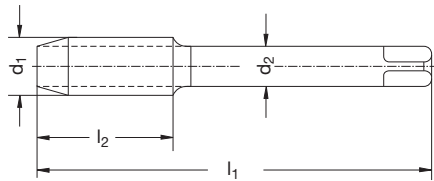

Katalog-Nr./Rabattgruppe No. de catalogue/ Groupe de remise		No. of catalogue/Discount group Nr. di catalogo/ Gruppo sconto								NB00/4		NC15/4		NC40/4	
d ₁ [mm]	P [mm]	l ₁ [mm]	l ₂ [mm]	l ₃ [mm]	d ₂ [mm]	□ [mm]	z	∅ [mm]	Code	€	Code	€	Code	€	
M 3	0,5	40	9	-	3,5	2,7	3	2,5	600 180	7,70					
M 4	0,7	45	12	-	4,5	3,4	3	3,3	600 182	7,70					
M 5	0,8	50	13	-	6	4,9	3	4,2	600 183	8,00					
M 6	1	56	15	-	6	4,9	3	5	600 184	8,00					
M 8	1,25	63	18	-	6	4,9	3	6,8	600 186	10,25					
M 10	1,5	70	20	-	7	5,5	3	8,5	600 188	12,25					
M 12	1,75	75	23	-	9	7	3	10,2	600 190	16,50					
M 3	0,5	40	5	-	3,5	2,7	3	2,5			600 200	8,20	600 220	8,20	
M 4	0,7	45	7	-	4,5	3,4	3	3,3			600 202	8,20	600 222	8,20	
M 5	0,8	50	8	-	6	4,9	3	4,2			600 203	8,20	600 223	8,20	
M 6	1	56	10	-	6	4,9	3	5			600 204	8,20	600 224	8,20	
M 8	1,25	63	13	-	6	4,9	3	6,8			600 206	11,00	600 226	11,00	
M 10	1,5	70	15	-	7	5,5	3	8,5			600 208	13,00	600 228	13,00	
M 12	1,75	75	18	-	9	7	3	10,2			600 210	17,75	600 230	17,75	

DIN 371

M 3 - M10

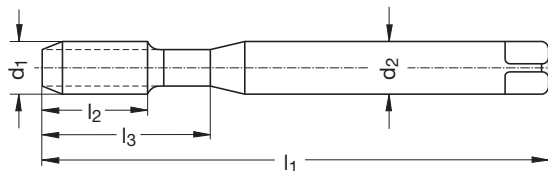

DIN 376

M12 - M30

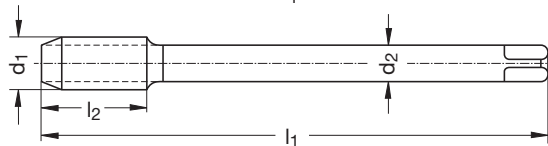

Katalog-Nr./Rabattgruppe No. de catalogue/ Groupe de remise		No. of catalogue/Discount group Nr. di catalogo/ Gruppo sconto								NC00/4	
d ₁ [mm]	P [mm]	l ₁ [mm]	l ₂ [mm]	l ₃ [mm]	d ₂ [mm]	□ [mm]	z	∅ [mm]	Code	€	
M 3	0,5	56	9	18	3,5	2,7	3	2,5	600 240	7,70	
M 4	0,7	63	12	21	4,5	3,4	3	3,3	600 242	7,70	
M 5	0,8	70	13	25	6	4,9	3	4,2	600 243	8,00	
M 6	1	80	15	30	6	4,9	3	5	600 244	8,00	
M 8	1,25	90	18	35	8	6,2	3	6,8	600 246	10,25	
M 10	1,5	100	20	39	10	8	3	8,5	600 248	12,25	
M 12	1,75	110	23	-	9	7	3	10,2	600 260	16,50	
M 14	2	110	25	-	11	9	3	12	600 261	20,00	
M 16	2	110	25	-	12	9	3	14	600 262	25,50	
M 18	2,5	125	30	-	14	11	3	15,5	600 263	34,00	
M 20	2,5	140	30	-	16	12	3	17,5	600 264	39,50	
M 22	2,5	140	30	-	18	14,5	3	19,5	600 265	51,00	
M 24	3	160	36	-	18	14,5	4	21	600 266	55,00	
M 27	3	160	36	-	20	16	4	24	600 267	66,00	
M 30	3,5	180	40	-	22	18	4	26,5	600 268	86,50	

M Typ N ISO 2 6H HSSE 60° P DIN 13

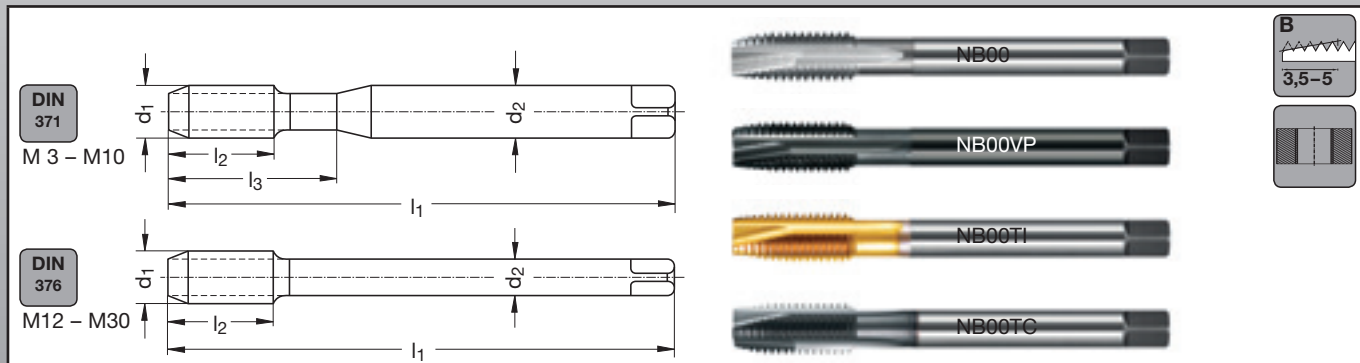

M
HSSE

Katalog-Nr./Rabattgruppe No. de catalogue / Groupe de remise		No. of catalogue / Discount group Nr. di catalogo / Gruppo sconto							NB00 / 4		NB00VP / 4		NB00TI / 4		NB00TC / 4	
d ₁ [mm]	P [mm]	l ₁ [mm]	l ₂ [mm]	l ₃ [mm]	d ₂ [mm]	□ [mm]	z	∅ [mm]	Code	€	Code	€	Code	€	Code	€
M 3	0,5	56	9	18	3,5	2,7	3	2,5	600 000	7,70	601 000	7,70	602 000	13,00	603 000	13,75
M 4	0,7	63	12	21	4,5	3,4	3	3,3	600 002	7,70	601 002	7,70	602 002	13,00	603 002	13,75
M 5	0,8	70	13	25	6	4,9	3	4,2	600 003	8,00	601 003	8,00	602 003	13,50	603 003	14,25
M 6	1	80	15	30	6	4,9	3	5	600 004	8,00	601 004	8,00	602 004	13,50	603 004	14,25
M 8	1,25	90	18	35	8	6,2	3	6,8	600 006	10,25	601 006	10,25	602 006	17,00	603 006	17,75
M 10	1,5	100	20	39	10	8	3	8,5	600 008	12,25	601 008	12,25	602 008	21,25	603 008	22,00
M 12	1,75	110	23	-	9	7	3	10,2	600 010	16,50	601 010	16,50	602 010	27,00	603 010	28,00
M 14	2	110	25	-	11	9	3	12	600 011	20,00	601 011	20,00	602 011	32,00	603 011	33,00
M 16	2	110	25	-	12	9	3	14	600 012	25,50	601 012	25,50	602 012	39,00	603 012	40,00
M 18	2,5	125	30	-	14	11	3	15,5	600 013	34,00	601 013	34,00	602 013	54,00	603 013	56,00
M 20	2,5	140	30	-	16	12	3	17,5	600 014	39,50	601 014	39,50	602 014	61,00	603 014	63,00
M 22	2,5	140	30	-	18	14,5	3	19,5	600 016	51,00	601 016	51,00	602 016	78,00	603 016	80,00
M 24	3	160	36	-	18	14,5	4	21	600 018	55,00	601 018	55,00	602 018	82,00	603 018	85,50
M 27	3	160	36	-	20	16	4	24	600 019	66,00	601 019	66,00	602 019	99,50	603 019	102,00
M 30	3,5	180	40	-	22	18	4	26,5	600 069	86,50	601 069	86,50	602 069	120,00	603 069	124,00

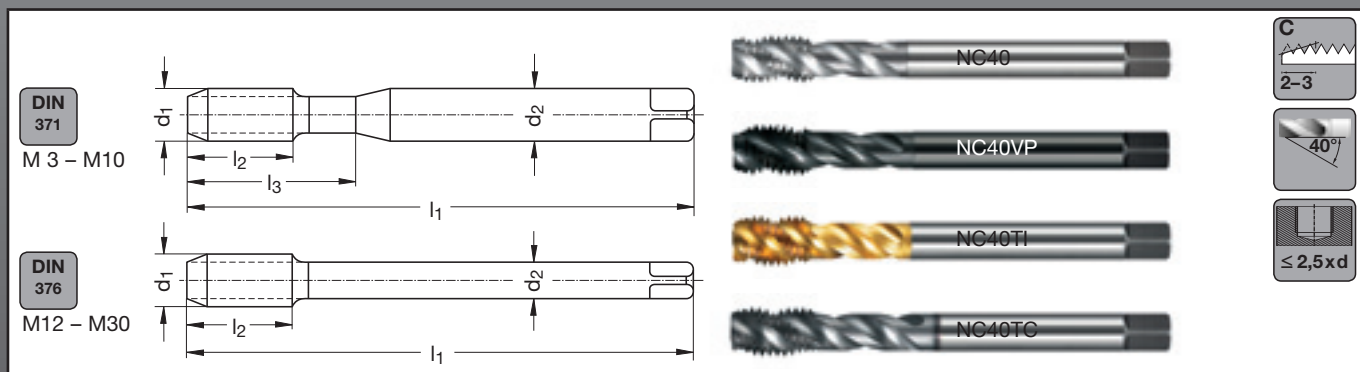

C
2-3
40°
≤ 2,5xd

Katalog-Nr./Rabattgruppe No. de catalogue / Groupe de remise		No. of catalogue / Discount group Nr. di catalogo / Gruppo sconto							NC40 / 4		NC40VP / 4		NC40TI / 4		NC40TC / 4	
d ₁ [mm]	P [mm]	l ₁ [mm]	l ₂ [mm]	l ₃ [mm]	d ₂ [mm]	□ [mm]	z	∅ [mm]	Code	€	Code	€	Code	€	Code	€
M 3	0,5	56	5	18	3,5	2,7	3	2,5	600 100	8,20	601 100	8,20	602 100	13,75	603 100	14,50
M 4	0,7	63	7	21	4,5	3,4	3	3,3	600 102	8,20	601 102	8,20	602 102	13,75	603 102	14,50
M 5	0,8	70	8	25	6	4,9	3	4,2	600 103	8,20	601 103	8,20	602 103	13,75	603 103	14,50
M 6	1	80	10	30	6	4,9	3	5	600 104	8,20	601 104	8,20	602 104	13,75	603 104	14,50
M 8	1,25	90	13	35	8	6,2	3	6,8	600 106	11,00	601 106	11,00	602 106	17,75	603 106	18,50
M 10	1,5	100	15	39	10	8	3	8,5	600 108	13,00	601 108	13,00	602 108	22,00	603 108	23,00
M 12	1,75	110	18	-	9	7	3	10,2	600 110	17,75	601 110	17,75	602 110	28,50	603 110	29,50
M 14	2	110	20	-	11	9	3	12	600 111	21,50	601 111	21,50	602 111	34,00	603 111	35,00
M 16	2	110	20	-	12	9	3	14	600 112	27,50	601 112	27,50	602 112	40,50	603 112	41,50
M 18	2,5	125	25	-	14	11	4	15,5	600 113	36,00	601 113	36,00	602 113	56,00	603 113	58,00
M 20	2,5	140	25	-	16	12	4	17,5	600 114	42,00	601 114	42,00	602 114	64,00	603 114	66,00
M 22	2,5	140	25	-	18	14,5	4	19,5	600 116	54,00	601 116	54,00	602 116	80,00	603 116	82,00
M 24	3	160	30	-	18	14,5	4	21	600 118	57,00	601 118	57,00	602 118	84,00	603 118	87,50
M 27	3	160	30	-	20	16	4	24	600 119	69,00	601 119	69,00	602 119	102,00	603 119	106,00
M 30	3,5	180	35	-	22	18	4	26,5	600 169	91,50	601 169	91,50	602 169	124,00	603 169	126,00

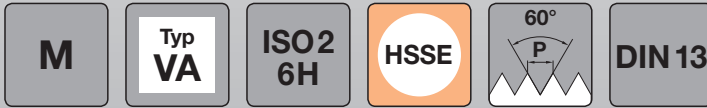

M

HSSE

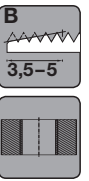
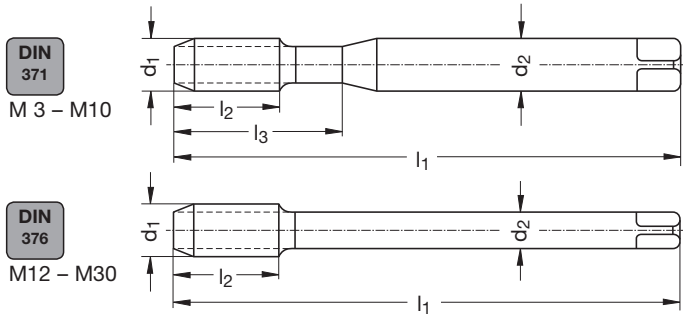

Katalog-Nr./Rabattgruppe No. de catalogue/ Groupe de remise		No. of catalogue/Discount group Nr. di catalogo/ Gruppo sconto								VAB00 / 4		VAB00VP / 4		VAB00TI / 4		VAB00TC / 4	
										-		VP		TiN		TiCN	
d ₁ [mm]	P [mm]	l ₁ [mm]	l ₂ [mm]	l ₃ [mm]	d ₂ [mm]	□ [mm]	z	∅ [mm]	Code	€	Code	€	Code	€	Code	€	
M 3	0,5	56	9	18	3,5	2,7	3	2,5	600 020	8,65	601 020	8,65	602 020	14,25	603 020	14,75	
M 4	0,7	63	12	21	4,5	3,4	3	3,3	600 022	8,65	601 022	8,65	602 022	14,25	603 022	14,75	
M 5	0,8	70	13	25	6	4,9	3	4,2	600 023	8,65	601 023	8,65	602 023	14,25	603 023	14,75	
M 6	1	80	15	30	6	4,9	3	5	600 024	8,65	601 024	8,65	602 024	14,25	603 024	14,75	
M 8	1,25	90	18	35	8	6,2	3	6,8	600 026	11,50	601 026	11,50	602 026	18,25	603 026	19,00	
M 10	1,5	100	20	39	10	8	3	8,5	600 028	13,75	601 028	13,75	602 028	22,75	603 028	23,50	
M 12	1,75	110	23	-	9	7	3	10,2	600 030	18,25	601 030	18,25	602 030	28,50	603 030	29,50	
M 14	2	110	25	-	11	9	3	12	600 031	22,50	601 031	22,50	602 031	34,50	603 031	35,50	
M 16	2	110	25	-	12	9	3	14	600 032	28,25	601 032	28,25	602 032	41,00	603 032	42,75	
M 18	2,5	125	30	-	14	11	3	15,5	600 033	36,50	601 033	36,50	602 033	56,00	603 033	58,00	
M 20	2,5	140	30	-	16	12	3	17,5	600 034	43,00	601 034	43,00	602 034	64,00	603 034	66,00	
M 22	2,5	140	30	-	18	14,5	3	19,5	600 036	54,50	601 036	54,50	602 036	80,00	603 036	82,00	
M 24	3	160	36	-	18	14,5	4	21	600 038	60,50	601 038	60,50	602 038	87,50	603 038	91,50	
M 27	3	160	36	-	20	16	4	24	600 039	72,00	601 039	72,00	602 039	104,00	603 039	110,00	
M 30	3,5	180	40	-	22	18	4	26,5	600 071	99,50	601 071	99,50	602 071	132,00	603 071	134,00	

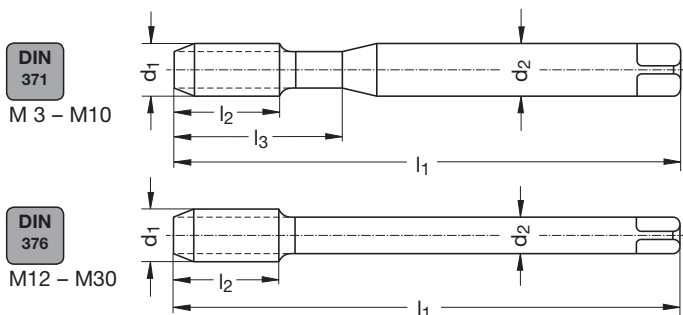

Katalog-Nr./Rabattgruppe No. de catalogue/ Groupe de remise		No. of catalogue/Discount group Nr. di catalogo/ Gruppo sconto								VAC40 / 4		VAC40VP / 4		VAC40TI / 4		VAC40TC / 4	
										-		VP		TiN		TiCN	
d ₁ [mm]	P [mm]	l ₁ [mm]	l ₂ [mm]	l ₃ [mm]	d ₂ [mm]	□ [mm]	z	∅ [mm]	Code	€	Code	€	Code	€	Code	€	
M 3	0,5	56	5	18	3,5	2,7	3	2,5	600 120	9,05	601 120	9,05	602 120	14,50	603 120	15,00	
M 4	0,7	63	7	21	4,5	3,4	3	3,3	600 122	9,05	601 122	9,05	602 122	14,50	603 122	15,00	
M 5	0,8	70	8	25	6	4,9	3	4,2	600 123	9,35	601 123	9,35	602 123	14,75	603 123	15,25	
M 6	1	80	10	30	6	4,9	3	5	600 124	9,35	601 124	9,35	602 124	14,75	603 124	15,25	
M 8	1,25	90	13	35	8	6,2	3	6,8	600 126	11,75	601 126	11,75	602 126	18,50	603 126	19,50	
M 10	1,5	100	15	39	10	8	3	8,5	600 128	14,00	601 128	14,00	602 128	23,00	603 128	23,75	
M 12	1,75	110	18	-	9	7	3	10,2	600 130	18,50	601 130	18,50	602 130	29,00	603 130	30,00	
M 14	2	110	20	-	11	9	3	12	600 131	23,00	601 131	23,00	602 131	34,50	603 131	35,50	
M 16	2	110	20	-	12	9	4	14	600 132	28,25	601 132	28,25	602 132	41,00	603 132	42,75	
M 18	2,5	125	25	-	14	11	4	15,5	600 133	38,50	601 133	38,50	602 133	58,00	603 133	60,00	
M 20	2,5	140	25	-	16	12	4	17,5	600 134	43,50	601 134	43,50	602 134	65,00	603 134	67,00	
M 22	2,5	140	25	-	18	14,5	4	19,5	600 136	56,50	601 136	56,50	602 136	82,00	603 136	84,00	
M 24	3	160	30	-	18	14,5	4	21	600 138	62,50	601 138	62,50	602 138	90,50	603 138	93,50	
M 27	3	160	30	-	20	16	4	24	600 139	74,00	601 139	74,00	602 139	108,00	603 139	112,00	
M 30	3,5	180	35	-	22	18	4	26,5	600 171	103,00	601 171	103,00	602 171	134,00	603 171	138,00	

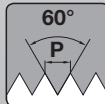
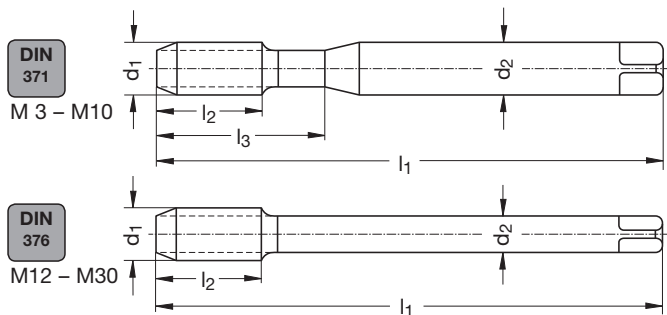
MTyp
GG**6HX****HSSE****DIN 13****M****HSSE**

Katalog-Nr./Rabattgruppe		No. of catalogue / Discount group		GGC00TC / 4							
No. de catalogue / Groupe de remise		Nr. di catalogo / Gruppo sconto		TiCN							
d ₁ [mm]	P [mm]	l ₁ [mm]	l ₂ [mm]	l ₃ [mm]	d ₂ [mm]	□ [mm]	z	∅ [mm]	Code	€	
M 3	0,5	56	9	18	3,5	2,7	3	2,5	603 080	15,00	
M 4	0,7	63	12	21	4,5	3,4	3	3,3	603 082	15,00	
M 5	0,8	70	13	25	6	4,9	3	4,2	603 083	15,25	
M 6	1	80	15	30	6	4,9	3	5	603 084	15,25	
M 8	1,25	90	18	35	8	6,2	4	6,8	603 086	21,75	
M 10	1,5	100	20	39	10	8	4	8,5	603 088	25,00	
M 12	1,75	110	23	-	9	7	4	10,2	603 090	33,00	
M 14	2	110	25	-	11	9	4	12	603 091	39,00	
M 16	2	110	25	-	12	9	4	14	603 092	47,75	
M 18	2,5	125	30	-	14	11	4	15,5	603 093	61,00	
M 20	2,5	140	30	-	16	12	4	17,5	603 094	75,00	
M 22	2,5	140	30	-	18	14,5	4	19,5	603 095	90,50	
M 24	3	160	36	-	18	14,5	4	21	603 097	94,50	
M 27	3	160	36	-	20	16	4	24	603 098	110,00	
M 30	3,5	180	40	-	22	18	4	26,5	603 099	136,00	

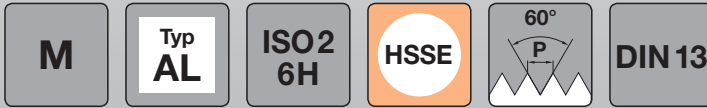

M

HSSE

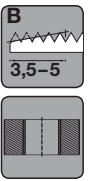
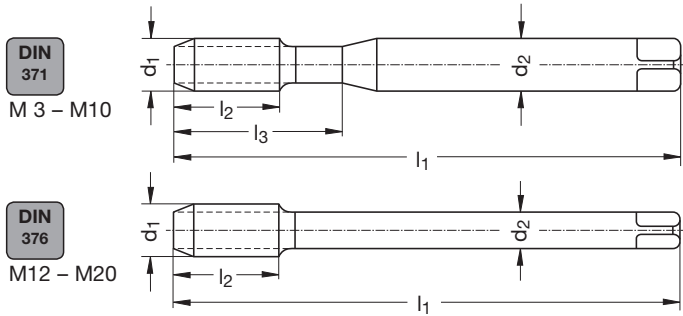

Katalog-Nr./Rabattgruppe No. de catalogue / Groupe de remise		No. of catalogue / Discount group Nr. di catalogo / Gruppo sconto		ALB00 / 4						
d ₁ [mm]	P [mm]	l ₁ [mm]	l ₂ [mm]	l ₃ [mm]	d ₂ [mm]	□ [mm]	z	∅ [mm]	Code	€
M 3	0,5	56	9	18	3,5	2,7	3	2,5	600 040	7,70
M 4	0,7	63	12	21	4,5	3,4	3	3,3	600 042	7,70
M 5	0,8	70	13	25	6	4,9	3	4,2	600 043	8,00
M 6	1	80	15	30	6	4,9	3	5	600 044	8,00
M 8	1,25	90	18	35	8	6,2	3	6,8	600 046	10,25
M 10	1,5	100	20	39	10	8	3	8,5	600 048	12,25
M 12	1,75	110	23	-	9	7	3	10,2	600 050	16,50
M 14	2	110	25	-	11	9	3	12	600 051	20,00
M 16	2	110	25	-	12	9	3	14	600 052	25,00
M 18	2,5	125	30	-	14	11	3	15,5	600 053	34,00
M 20	2,5	140	30	-	16	12	3	17,5	600 054	39,50

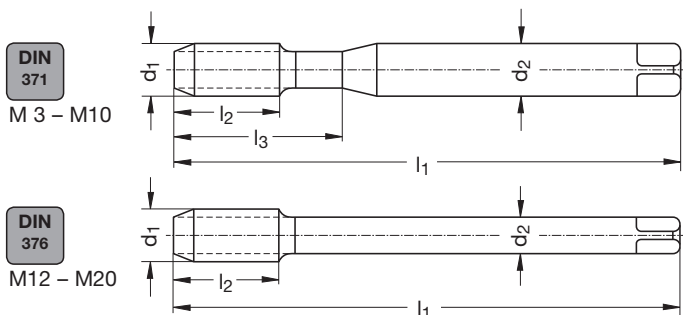

Katalog-Nr./Rabattgruppe No. de catalogue / Groupe de remise		No. of catalogue / Discount group Nr. di catalogo / Gruppo sconto		ALC45 / 4						
d ₁ [mm]	P [mm]	l ₁ [mm]	l ₂ [mm]	l ₃ [mm]	d ₂ [mm]	□ [mm]	z	∅ [mm]	Code	€
M 3	0,5	56	5	18	3,5	2,7	2	2,5	600 140	8,65
M 4	0,7	63	7	21	4,5	3,4	2	3,3	600 142	8,65
M 5	0,8	70	8	25	6	4,9	2	4,2	600 143	9,35
M 6	1	80	10	30	6	4,9	2	5	600 144	9,35
M 8	1,25	90	13	35	8	6,2	2	6,8	600 146	11,00
M 10	1,5	100	15	39	10	8	2	8,5	600 148	12,50
M 12	1,75	110	18	-	9	7	2	10,2	600 150	17,25
M 14	2	110	20	-	11	9	2	12	600 151	21,00
M 16	2	110	20	-	12	9	2	14	600 152	26,50
M 18	2,5	125	25	-	14	11	3	15,5	600 153	35,00
M 20	2,5	140	25	-	16	12	3	17,5	600 154	40,50

M Typ H ISO2 6H HSSE-PM HSSE 60° P DIN 13

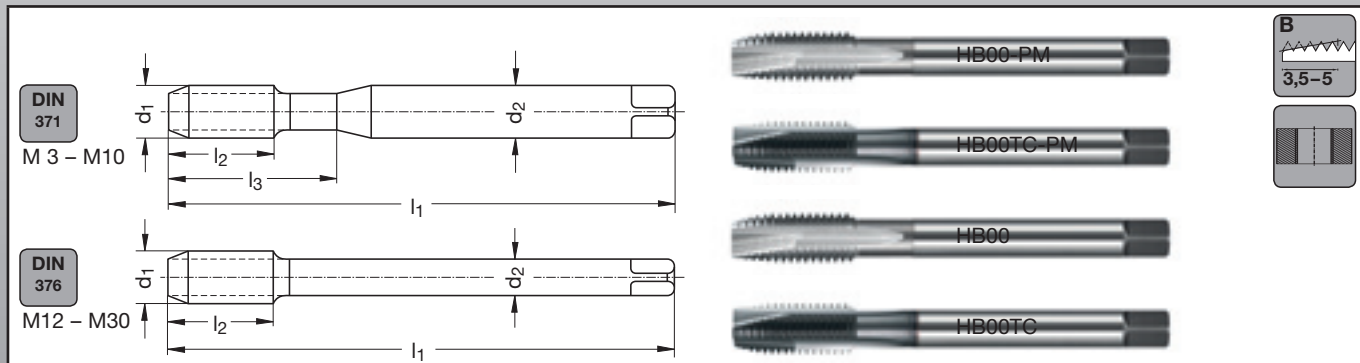

Katalog-Nr./Rabattgruppe No. de catalogue / Groupe de remise		No. of catalogue / Discount group Nr. di catalogo / Gruppo sconto		HB00-PM / 4		HB00TC-PM / 4		HB00 / 4		HB00TC / 4						
d ₁ [mm]	P [mm]	l ₁ [mm]	l ₂ [mm]	l ₃ [mm]	d ₂ [mm]	□ [mm]	z	∅ [mm]	Code	€	Code	€	Code	€	Code	€
M 3	0,5	56	9	18	3,5	2,7	3	2,5	610 000	18,00	614 000	24,00	600 760	9,60	603 760	15,50
M 4	0,7	63	12	21	4,5	3,4	3	3,3	610 002	18,00	614 002	24,00	600 762	9,60	603 762	15,50
M 5	0,8	70	13	25	6	4,9	3	4,2	610 003	18,75	614 003	25,00	600 763	9,90	603 763	15,75
M 6	1	80	15	30	6	4,9	3	5	610 004	18,75	614 004	25,00	600 764	9,90	603 764	15,75
M 8	1,25	90	18	35	8	6,2	3	6,8	610 006	23,00	614 006	30,50	600 766	12,75	603 766	20,50
M 10	1,5	100	20	39	10	8	3	8,5	610 008	28,00	614 008	37,50	600 768	15,25	603 768	25,00
M 12	1,75	110	23	-	9	7	3	10,2	610 010	34,00	614 010	45,75	600 770	20,25	603 770	31,50
M 14	2	110	25	-	11	9	3	12					600 771	25,25	603 771	38,00
M 16	2	110	25	-	12	9	3	14					600 772	30,50	603 772	45,75
M 18	2,5	125	30	-	14	11	3	15,5					600 773	40,75	603 773	62,00
M 20	2,5	140	30	-	16	12	3	17,5					600 774	48,50	603 774	71,00
M 22	2,5	140	30	-	18	14,5	3	19,5					600 775	60,00	603 775	88,50
M 24	3	160	36	-	18	14,5	4	21					600 776	65,50	603 776	95,50
M 27	3	160	36	-	20	16	4	24					600 777	79,50	603 777	116,00
M 30	3,5	180	40	-	22	18	4	26,5					600 778	110,00	603 778	144,00

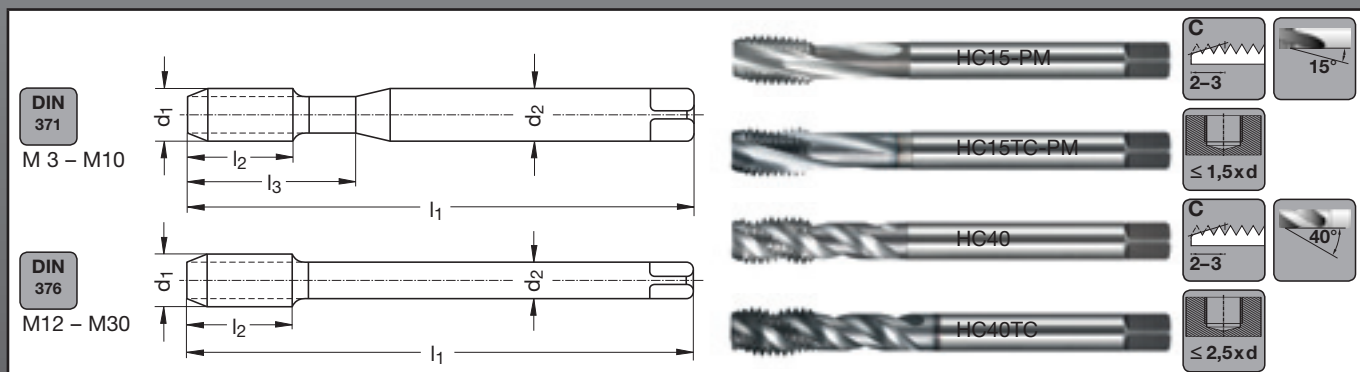

Katalog-Nr./Rabattgruppe No. de catalogue / Groupe de remise		No. of catalogue / Discount group Nr. di catalogo / Gruppo sconto		HC15-PM / 4		HC15TC-PM / 4		HC40 / 4		HC40TC / 4						
d ₁ [mm]	P [mm]	l ₁ [mm]	l ₂ [mm]	l ₃ [mm]	d ₂ [mm]	□ [mm]	z	∅ [mm]	Code	€	Code	€	Code	€	Code	€
M 3	0,5	56	5	18	3,5	2,7	3	2,5	610 020	19,75	614 020	26,00	600 780	9,80	603 780	15,75
M 4	0,7	63	7	21	4,5	3,4	3	3,3	610 022	19,75	614 022	26,00	600 782	9,80	603 782	15,75
M 5	0,8	70	8	25	6	4,9	3	4,2	610 023	20,75	614 023	27,00	600 783	10,00	603 783	16,00
M 6	1	80	10	30	6	4,9	3	5	610 024	21,75	614 024	28,50	600 784	10,25	603 784	16,00
M 8	1,25	90	13	35	8	6,2	3	6,8	610 026	24,00	614 026	31,50	600 786	12,75	603 786	20,50
M 10	1,5	100	15	39	10	8	3	8,5	610 028	27,50	614 028	37,00	600 788	15,50	603 788	25,50
M 12	1,75	110	18	-	9	7	3	10,2	610 030	35,50	614 030	47,25	600 790	21,00	603 790	32,50
M 14	2	110	20	-	11	9	4	12					600 791	25,25	603 791	38,00
M 16	2	110	20	-	12	9	4	14					600 792	32,25	603 792	46,75
M 18	2,5	125	25	-	14	11	4	15,5					600 793	43,25	603 793	65,00
M 20	2,5	140	25	-	16	12	4	17,5					600 794	51,00	603 794	74,00
M 22	2,5	140	25	-	18	14,5	4	19,5					600 795	66,50	603 795	95,50
M 24	3	160	30	-	18	14,5	4	21					600 796	68,50	603 796	98,50
M 27	3	160	30	-	20	16	4	24					600 797	81,50	603 797	118,00
M 30	3,5	180	35	-	22	18	5	26,5					600 798	112,00	603 798	146,00



M

HSSE

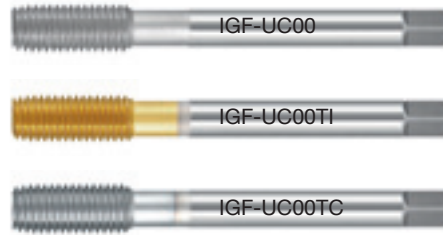
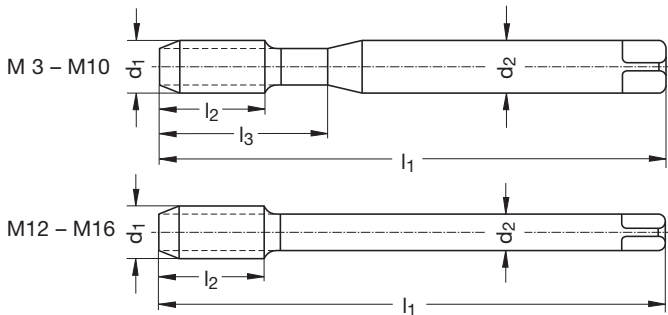

Katalog-Nr./Rabattgruppe No. de catalogue / Groupe de remise		No. of catalogue / Discount group Nr. di catalogo / Gruppo sconto							IGF-UC00 / 4		IGF-UC00TI / 4		IGF-UC00TC / 4	
									-		TiN		TiCN	
d ₁ [mm]	P [mm]	l ₁ [mm]	l ₂ [mm]	l ₃ [mm]	d ₂ [mm]	□ [mm]	z	Ø [mm]	Code	€	Code	€	Code	€
M 3	0,5	56	11	18	3,5	2,7	4	2,8	600 300	14,75	602 300	20,25	603 300	20,75
M 4	0,7	63	13	21	4,5	3,4	5	3,7	600 302	20,75	602 302	26,50	603 302	27,00
M 5	0,8	70	16	25	6	4,9	5	4,65	600 303	23,75	602 303	29,50	603 303	30,00
M 6	1	80	19	30	6	4,9	5	5,55	600 304	25,00	602 304	30,50	603 304	31,00
M 8	1,25	90	22	35	8	6,2	6	7,4	600 306	28,00	602 306	34,50	603 306	35,00
M 10	1,5	100	24	39	10	8	5	9,3	600 308	33,00	602 308	41,50	603 308	42,75
M 12	1,75	110	28	-	9	7	5	11,2	600 310	47,25	602 310	58,00	603 310	59,00
M 14	2	110	30	-	11	9	8	13	600 311	58,00	602 311	71,00	603 311	72,00
M 16	2	110	32	-	12	9	8	15	600 312	79,00	602 312	93,50	603 312	94,50

SN

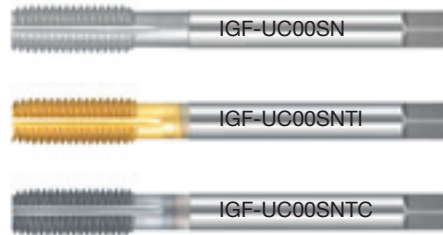
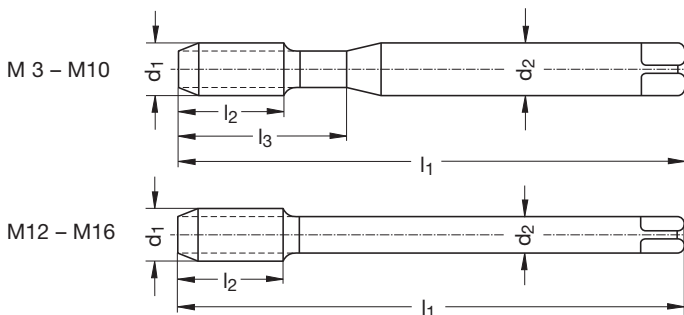

Katalog-Nr./Rabattgruppe No. de catalogue / Groupe de remise		No. of catalogue / Discount group Nr. di catalogo / Gruppo sconto							IGF-UC00SN / 4		IGF-UC00SNTI / 4		IGF-UC00SNTC / 4	
									-		TiN		TiCN	
d ₁ [mm]	P [mm]	l ₁ [mm]	l ₂ [mm]	l ₃ [mm]	d ₂ [mm]	□ [mm]	z	Ø [mm]	Code	€	Code	€	Code	€
M 3	0,5	56	11	18	3,5	2,7	4	2,8	600 280	15,50	602 280	21,00	603 280	21,75
M 4	0,7	63	13	21	4,5	3,4	5	3,7	600 282	21,75	602 282	27,50	603 282	28,50
M 5	0,8	70	16	25	6	4,9	5	4,65	600 283	25,00	602 283	30,50	603 283	31,00
M 6	1	80	19	30	6	4,9	5	5,55	600 284	26,50	602 284	32,00	603 284	32,50
M 8	1,25	90	22	35	8	6,2	5	7,4	600 286	29,00	602 286	35,50	603 286	36,50
M 10	1,5	100	24	39	10	8	5	9,3	600 288	34,50	602 288	43,75	603 288	44,75
M 12	1,75	110	28	-	9	7	5	11,2	600 290	49,25	602 290	60,00	603 290	61,00
M 14	2	110	30	-	11	9	8	13	600 291	61,00	602 291	74,00	603 291	75,00
M 16	2	110	32	-	12	9	8	15	600 292	83,00	602 292	97,50	603 292	98,50

MF

Typ
NTyp
VAISO 2
6H

HSSE

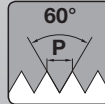
DIN
374

DIN 13

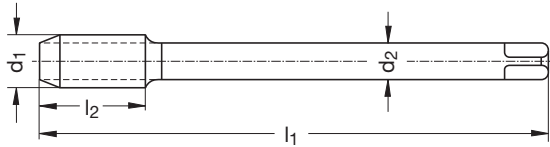

MF

HSSE

Katalog-Nr./Rabattgruppe		No. of catalogue / Discount group		NB00-MF / 4		VAB00VP-MF / 4			
No. de catalogue / Groupe de remise		Nr. di catalogo / Gruppo sconto		-		VP			
d ₁ [mm]	P [mm]	l ₁ [mm]	l ₂ [mm]	d ₂ [mm]	□ [mm]	z	∅ [mm]	Code	€
M 4	x 0,5	63	12	2,8	2,1	3	3,5	600 402	12,00
M 5	x 0,5	70	13	3,5	2,7	3	4,5	600 403	12,75
M 6	x 0,5	80	15	4,5	3,4	3	5,5	600 404	13,00
M 6	x 0,75	80	15	4,5	3,4	3	5,2	600 405	12,75
M 8	x 0,75	80	15	6	4,9	3	7,2	600 408	15,50
M 8	x 1	90	18	6	4,9	3	7	600 409	14,00
M 10	x 0,75	90	20	7	5,5	3	9,2	600 411	22,50
M 10	x 1	90	20	7	5,5	3	9	600 412	16,25
M 10	x 1,25	100	20	7	5,5	3	8,8	600 413	16,25
M 12	x 1	100	21	9	7	3	11	600 415	19,00
M 12	x 1,25	100	21	9	7	3	10,8	600 416	21,75
M 12	x 1,5	100	21	9	7	3	10,5	600 417	18,00
M 14	x 1,5	100	21	11	9	3	12,5	600 420	24,00
M 16	x 1,5	100	21	12	9	3	14,5	600 424	28,50
M 18	x 1,5	110	24	14	11	3	16,5	600 426	35,00
M 20	x 1,5	125	24	16	12	3	18,5	600 429	40,50
								Code	€
								601 061	15,00
								601 063	16,25
								601 064	18,50
								601 065	23,25
								601 066	21,00
								601 068	33,00
								601 070	52,00

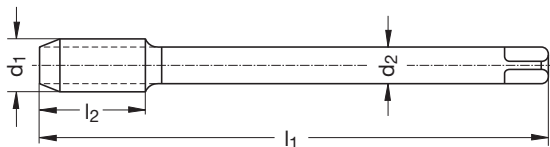

AG

Katalog-Nr./Rabattgruppe		No. of catalogue / Discount group		NC40-MF / 4		VAC40VP-MF / 4			
No. de catalogue / Groupe de remise		Nr. di catalogo / Gruppo sconto		-		VP			
d ₁ [mm]	P [mm]	l ₁ [mm]	l ₂ [mm]	d ₂ [mm]	□ [mm]	z	∅ [mm]	Code	€
M 4	x 0,5	63	7	2,8	2,1	3	3,5	600 502	13,50
M 5	x 0,5	70	8	3,5	2,7	3	4,5	600 503	13,50
M 6	x 0,5	80	10	4,5	3,4	3	5,5	600 504	13,50
M 6	x 0,75	80	10	4,5	3,4	3	5,2	600 505	13,50
M 8	x 0,75	80	10	6	4,9	3	7,2	600 508	15,75
M 8	x 1	90	13	6	4,9	3	7	600 509	14,50
M 10	x 1	90	12	7	5,5	3	9	600 512	16,50
M 10	x 1,25	100	15	7	5,5	3	8,8	600 513	22,75
M 12	x 1	100	14	9	7	3	11	600 515	20,00
M 12	x 1,25	100	14	9	7	3	10,8	600 516	25,50
M 12	x 1,5	100	14	9	7	3	10,5	600 517	18,50
M 14	x 1,5	100	16	11	9	3	12,5	600 520	24,25
M 16	x 1,5	100	16	12	9	4	14,5	600 524	29,50
M 18	x 1,5	110	20	14	11	4	16,5	600 526	36,00
M 20	x 1,5	125	20	16	12	4	18,5	600 529	41,50
								Code	€
								601 161	15,50
								601 162	24,00
								601 163	16,75
								601 164	18,75
								601 165	23,25
								601 166	22,25
								601 167	28,25
								601 168	34,50
								601 170	53,50

G

Typ
N

Typ
VA

HSSE

DIN
5156

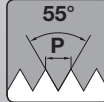

DIN
ISO 228

G

HSSE

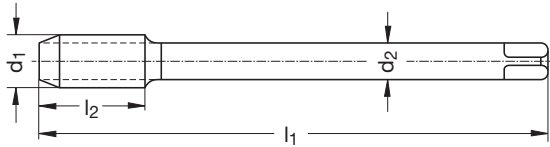

Katalog-Nr./Rabattgruppe No. de catalogue/Groupe de remise		No. of catalogue/Discount group Nr. di catalogo/Gruppo sconto							NB00-G/4		VAB00VP-G/4	
									VP			
P [Gg/1"]	d ₁ [mm]	l ₁ [mm]	l ₂ [mm]	d ₂ [mm]	□ [mm]	z	∅ [mm]	Code 	€	Code 	€	
G 1/8	28	9,728	90	20	7	5,5	3	8,8	600 690	18,25	601 200	20,00
G 1/4	19	13,157	100	21	11	9	3	11,8	600 691	24,50	601 201	27,50
G 3/8	19	16,662	100	21	12	9	3	15,25	600 692	28,00	601 202	33,50
G 1/2	14	20,955	125	24	16	12	3	19	600 693	40,50	601 203	48,25
G 5/8	14	22,911	125	24	18	14,5	4	21			601 204	64,50
G 3/4	14	26,441	140	26	20	16	4	24,5	600 695	67,00	601 205	77,00
G 1	11	33,249	160	30	25	20	4	30,75	600 697	95,50	601 207	123,00
G 1 1/8	11	37,897	170	30	28	22	4	35,3			601 208	152,00
G 1 1/4	11	41,91	170	30	32	24	4	39,5			601 209	182,00
G 1 3/8	11	44,323	180	32	36	29	4	41,9			601 210	224,00
G 1 1/2	11	47,803	190	32	36	29	6	45,25			601 211	252,00
G 1 3/4	11	53,746	200	32	40	32	6	51,3			601 212	348,00
G 2	11	59,614	200	40	45	35	6	57			601 213	590,00

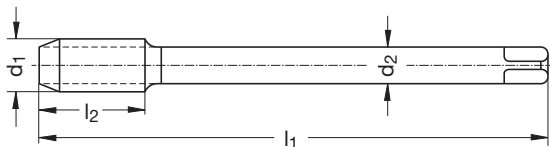

AG

Katalog-Nr./Rabattgruppe No. de catalogue/Groupe de remise		No. of catalogue/Discount group Nr. di catalogo/Gruppo sconto							NC40-G/4		VAC40VP-G/4	
									VP			
P [Gg/1"]	d ₁ [mm]	l ₁ [mm]	l ₂ [mm]	d ₂ [mm]	□ [mm]	z	∅ [mm]	Code 	€	Code 	€	
G 1/8	28	9,728	90	12	7	5,5	3	8,8	600 710	19,00	601 300	23,00
G 1/4	19	13,157	100	16	11	9	3	11,8	600 711	25,00	601 301	30,50
G 3/8	19	16,662	100	16	12	9	3	15,25	600 712	29,00	601 302	41,50
G 1/2	14	20,955	125	20	16	12	4	19	600 713	41,50	601 303	60,00
G 5/8	14	22,911	125	20	18	14,5	4	21			601 304	87,50
G 3/4	14	26,441	140	22	20	16	4	24,5	600 715	78,00	601 305	110,00
G 1	11	33,249	160	30	25	20	4	30,75	600 717	116,00	601 307	168,00
G 1 1/8	11	37,897	170	30	28	22	5	35,3			601 308	220,00
G 1 1/4	11	41,91	170	30	32	24	5	39,5			601 309	232,00
G 1 3/8	11	44,323	180	32	36	29	5	41,9			601 310	288,00
G 1 1/2	11	47,803	190	32	36	29	5	45,25			601 311	320,00
G 1 3/4	11	53,746	200	32	40	32	5	51,3			601 312	402,00
G 2	11	59,614	200	40	45	35	5	57			601 313	650,00

UNC Typ **N** 2B **HSSE** DIN 2184-1 60° P ANSI B 1.1

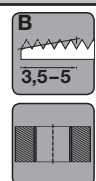
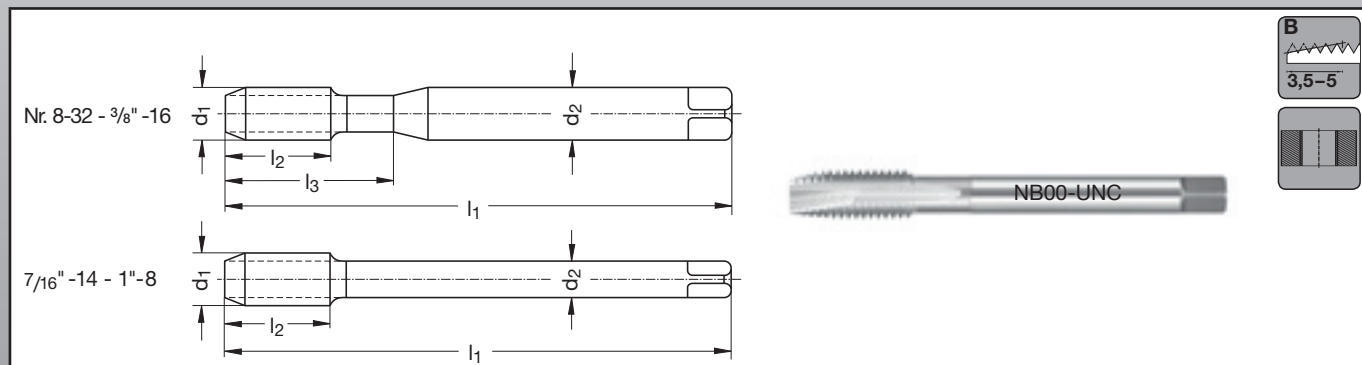

UNC

HSSE

Katalog-Nr./Rabattgruppe No. de catalogue / Groupe de remise		No. of catalogue / Discount group Nr. di catalogo / Gruppo sconto		NB00-UNC / 4					
P [Gg/1"]	d ₁ [mm]	l ₁ [mm]	l ₂ [mm]	d ₂ [mm]	□	z	∅	Code	€
UNC # 8 - 32	4,166	63	12	4,5	3,4	3	3,5	600 606	14,00
UNC # 10 - 24	4,826	70	13	6	4,9	3	3,9	600 607	14,50
UNC # 12 - 24	5,486	80	15	6	4,9	3	4,5	600 608	15,00
UNC 1/4" - 20	6,35	80	15	7	5,5	3	5,2	600 609	16,50
UNC 5/16" - 18	7,938	90	18	8	6,2	3	6,6	600 610	17,25
UNC 3/8" - 16	9,525	90	20	9	7	3	8	600 611	20,50
UNC 7/16" - 14	11,113	100	20	8	6,2	3	9,4	600 620	20,75
UNC 1/2" - 13	12,7	110	23	9	7	3	10,75	600 621	26,50
UNC 9/16" - 12	14,288	110	25	11	9	3	12,25	600 622	40,00
UNC 5/8" - 11	15,875	110	25	12	9	3	13,5	600 623	34,50
UNC 3/4" - 10	19,05	125	30	14	11	3	16,5	600 624	39,00
UNC 7/8" - 9	22,225	140	30	18	14,5	3	19,5	600 625	48,25
UNC 1" - 8	25,400	160	36	18	14,5	3	22,25	600 626	67,00

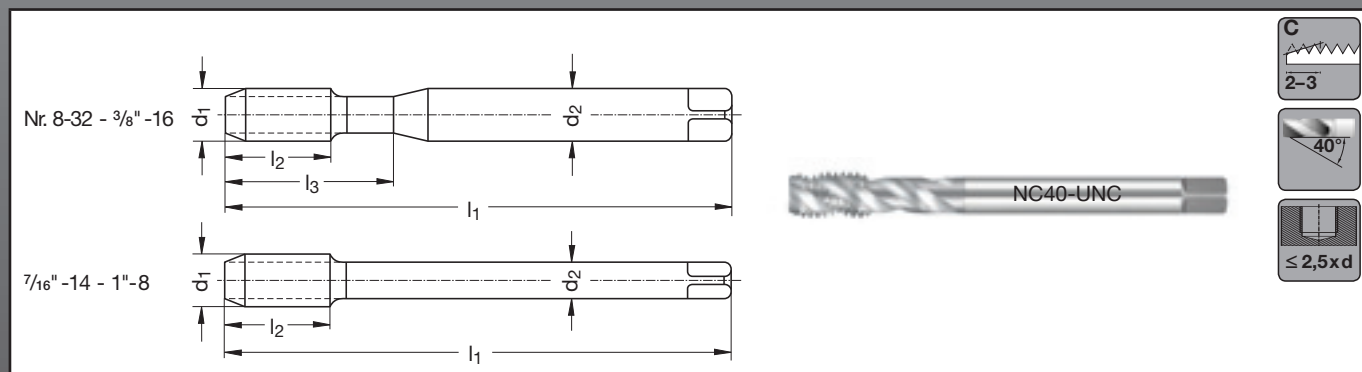

Katalog-Nr./Rabattgruppe No. de catalogue / Groupe de remise		No. of catalogue / Discount group Nr. di catalogo / Gruppo sconto		NC40-UNC / 4					
P [Gg/1"]	d ₁ [mm]	l ₁ [mm]	l ₂ [mm]	d ₂ [mm]	□	z	∅	Code	€
UNC # 8 - 32	4,166	63	7	4,5	3,4	3	3,5	600 635	14,25
UNC # 10 - 24	4,826	70	8	6	4,9	3	3,9	600 636	15,25
UNC # 12 - 24	5,486	80	10	6	4,9	3	4,5	600 637	17,00
UNC 1/4" - 20	6,35	80	10	7	5,5	3	5,2	600 638	17,00
UNC 5/16" - 18	7,938	90	13	8	6,2	3	6,6	600 639	18,00
UNC 3/8" - 16	9,525	90	15	9	7	3	8	600 640	21,25
UNC 7/16" - 14	11,113	100	18	8	6,2	3	9,4	600 650	21,25
UNC 1/2" - 13	12,7	110	20	9	7	3	10,75	600 651	28,00
UNC 9/16" - 12	14,288	110	20	11	9	3	12,25	600 652	41,00
UNC 5/8" - 11	15,875	110	20	12	9	3	13,5	600 653	35,00
UNC 3/4" - 10	19,05	125	25	14	11	4	16,5	600 654	39,50
UNC 7/8" - 9	22,225	140	25	18	14,5	4	19,5	600 655	49,25
UNC 1" - 8	25,400	160	30	18	14,5	4	22,25	600 656	68,00



UNF

HSSE

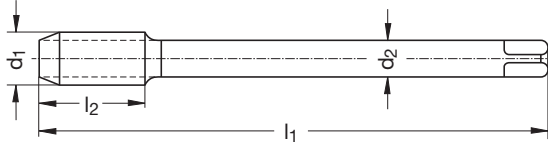

Katalog-Nr./Rabattgruppe No. de catalogue / Groupe de remise		No. of catalogue / Discount group Nr. di catalogo / Gruppo sconto								NB00-UNF / 4			
P [Gg/1"]	d ₁ [mm]	l ₁ [mm]	l ₂ [mm]	d ₂ [mm]	□ [mm]	z	∅ [mm]	∅ [mm]	Code	€			
UNF # 10 - 32	4,826	70	13	3,5	2,7	3	4,1	600 670	20,50				
UNF # 12 - 28	5,486	80	15	4	3	3	4,65	600 672	24,00				
UNF 1/4" - 28	6,35	80	15	4,5	3,4	3	5,5	600 673	22,75				
UNF 5/16" - 24	7,938	90	18	6	4,9	3	6,9	600 674	24,50				
UNF 3/8" - 24	9,525	90	20	7	5,5	3	8,5	600 675	26,00				
UNF 7/16" - 20	11,113	100	20	8	6,2	3	9,9	600 676	32,00				
UNF 1/2" - 20	12,7	100	21	9	7	3	11,5	600 677	33,50				
UNF 5/8" - 18	15,875	100	21	12	9	3	14,5	600 679	43,25				
UNF 3/4" - 16	19,05	110	24	14	11	3	17,5	600 680	55,00				
UNF 7/8" - 14	22,225	125	24	18	14,5	3	20,5	600 681	71,00				
UNF 1" - 12	25,4	140	26	18	14,5	3	23,25	600 682	102,00				

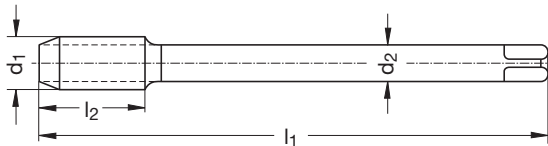

Katalog-Nr./Rabattgruppe No. de catalogue / Groupe de remise		No. of catalogue / Discount group Nr. di catalogo / Gruppo sconto								NC40-UNF / 4			
P [Gg/1"]	d ₁ [mm]	l ₁ [mm]	l ₂ [mm]	d ₂ [mm]	□ [mm]	z	∅ [mm]	∅ [mm]	Code	€			
UNF # 10 - 32	4,826	70	8	3,5	2,7	3	4,1	600 853	21,25				
UNF # 12 - 28	5,486	80	10	4	3	3	4,65	600 854	25,00				
UNF 1/4" - 28	6,35	80	10	4,5	2,7	3	5,5	600 855	23,75				
UNF 5/16" - 24	7,938	90	13	6	4,9	3	6,9	600 856	26,00				
UNF 3/8" - 24	9,525	90	15	7	5,5	3	8,5	600 857	28,00				
UNF 7/16" - 20	11,113	100	15	8	6,2	3	9,9	600 858	34,00				
UNF 1/2" - 20	12,7	100	14	9	7	3	11,5	600 859	35,00				
UNF 5/8" - 18	15,875	100	16	12	9	3	14,5	600 861	46,25				
UNF 3/4" - 16	19,05	110	20	14	11	3	17,5	600 862	58,00				
UNF 7/8" - 14	22,225	125	20	18	14,5	3	20,5	600 863	74,00				
UNF 1" - 12	25,4	140	22	18	14,5	3	23,25	600 864	108,00				



Gewindebohrerkassetten mit Kernlochbohrern
 Tap cases with drills
 Coffrets de tarauds avec forets d'avant trou
 Cassette di maschi con relative punte per prefori

Abmessung Dimension Dimensione	Code 	Rabattgruppe Discount group Groupe de remise Gruppo sconto 4	
M 3 - M12	600 994	110,00 €	1 x M 3 - M 4 - M 5 - M 6 - M 8 - M10 - M12 1 x \varnothing 2,5 - 3,3 - 4,2 - 5,0 - 6,8 - 8,5 - 10,2 DIN 338, HSS, Typ N.



Gewindebohrerkassetten mit Kernlochbohrern
 Tap cases with drills
 Coffrets de tarauds avec forets d'avant trou
 Cassette di maschi con relative punte per prefori

Abmessung Dimension Dimensione	Code 	Rabattgruppe Discount group Groupe de remise Gruppo sconto 4	
M 3 - M12	600 995	114,00 €	1 x M 3 - M 4 - M 5 - M 6 - M 8 - M10 - M12 1 x \varnothing 2,5 - 3,3 - 4,2 - 5,0 - 6,8 - 8,5 - 10,2 DIN 338, HSSE, Typ VA.



Gewindebohrerkassetten mit Kernlochbohrern
 Tap cases with drills
 Coffrets de tarauds avec forets d'avant trou
 Cassette di maschi con relative punte per prefori

Abmessung Dimension Dimensione	Code 	Rabattgruppe Discount group Groupe de remise Gruppo sconto 4	
M 3 - M12	600 996	112,00 €	1 x M 3 - M 4 - M 5 - M 6 - M 8 - M10 - M12 1 x \varnothing 2,5 - 3,3 - 4,2 - 5,0 - 6,8 - 8,5 - 10,2 DIN 338, HSS, Typ N.



Gewindebohrerkassetten mit Kernlochbohrern
 Tap cases with drills
 Coffrets de tarauds avec forets d'avant trou
 Cassette di maschi con relative punte per prefori

Abmessung Dimension Dimensione	Code 	Rabattgruppe Discount group Groupe de remise Gruppo sconto 4	
M 3 - M12	600 997	118,00 €	1 x M 3 - M 4 - M 5 - M 6 - M 8 - M10 - M12 1 x \varnothing 2,5 - 3,3 - 4,2 - 5,0 - 6,8 - 8,5 - 10,2 DIN 338, HSSE, Typ VA.



Werkstoffübersicht nach Werkstoffnummer (W.-Nr.)
 Work material overview according material-no. (W.-Nr.)
 Index-Groupe de matières selon numéro (W.-Nr.)
 Materiali da lavorare secondo nr. materiale (W.-Nr.)

W.-Nr.	DIN (DE)	Werkstoffgruppen Classification of work materials Groupes de matières Gruppo materiali		W.-Nr.	DIN (DE)	Werkstoffgruppen Classification of work materials Groupes de matières Gruppo materiali	
-	AFK Armidfaserverstärkt	7.3	6-8	1.0552	GS-52	1.1.3	6-8
-	Albanit	7.2	6-8	1.0558	GS-60	1.1.3	6-8
-	AMPCO 8	3.4	6-8	1.0570	St 52-3	1.1.1	6-8
-	AMPCO 12	3.4	6-8	1.0582	StE 355	1.1.4	6-8
-	AMPCO 15	3.4	6-8	1.0710	15 S 10	1.2.3	6-8
-	AMPCO 16	3.4	6-8	1.0715	9 SMn 28	1.2.3	6-8
-	AMPCO 18	3.5	6-8	1.0718	9 SMnPb 28	1.2.3	6-8
-	AMPCO 20	3.5	6-8	1.0721	10 S 20	1.2.3	6-8
-	AMPCO 21	3.6	6-8	1.0722	10 SPb 20	1.2.3	6-8
-	AMPCO 22	3.6	6-8	1.0723	15 S 20	1.2.3	6-8
-	AMPCO 25	3.6	6-8	1.0726	35 S 20	1.2.3	6-8
-	AMPCO 26	3.6	6-8	1.0727	45 S 20	1.2.3	6-8
-	ASP 23	1.5.3/8.2	6-8	1.0736	9 SMn 36	1.2.3	6-8
-	ASP 30	1.5.3/8.2	6-8	1.0737	9 SMnPb 36	1.2.3	6-8
-	ASP 60	1.5.3/8.2	6-8	1.1121	Ck 10	1.2.1	6-8
-	Bakelit	7.2	6-8	1.1132	Cq 15	1.2.4	6-8
-	CFK Kohlefaserverstärkt	7.3	6-8	1.1133	20 Mn 5	1.3.4/1.4.1	6-8
-	CPM 10 V	1.5.2/8.2	6-8	1.1140	Cm 15 (C 15 R)	1.2.1	6-8
-	CPM REX M4	1.5.3/8.2	6-8	1.1141	Ck 15	1.2.1	6-8
-	Degolan	7.1	6-8	1.1151	Ck 22	1.2.2	6-8
-	Ferrotic	8.1	6-8	1.1152	Cq 22	1.2.4	6-8
-	Ferrotitanit	8.1	6-8	1.1157	40 Mn 4	1.3.4	6-8
-	Ferrozell	7.2	6-8	1.1157	40 Mn 4 V	1.4.1	6-8
-	G-AISI 17 Cu 4	4.5	6-8	1.1169	20 Mn 6	1.3.1	6-8
-	G-AISI 21 CuNiMg	4.5	6-8	1.1170	28 Mn 6	1.3.4	6-8
-	G-AISI 25 CuNiMg	4.5	6-8	1.1170	28 Mn 6 V	1.4.1	6-8
-	GFK Glasfaserverstärkt	7.3	6-8	1.1172	Cq 35	1.2.4	6-8
-	GGV-30	2.4	6-8	1.1178	Ck 30	1.2.2	6-8
-	GGV-40	2.4	6-8	1.1180	Cm 35	1.2.2	6-8
-	HARDOX 400	1.4.4	6-8	1.1181	Ck 35	1.2.2	6-8
-	HARDOX 500	8.2.1	6-8	1.1191	Ck 45	1.2.2	6-8
-	Hostaform	7.1	6-8	1.1192	Cq 45	1.2.4	6-8
-	Hostalen	7.1	6-8	1.1520	C 70 W1	1.5.1/8.2	6-8
-	Makralon	7.1	6-8	1.1525	C 80 W1	1.5.1/8.2	6-8
-	Pertinax	7.2	6-8	1.1545	C 105 W1	1.5.1/8.2	6-8
-	Polystyrol	7.1	6-8	1.1554	C 110 W	1.5.1/8.2	6-8
-	Resopal	7.2	6-8	1.1730	C 45 W	1.5.1/8.2	6-8
-	TOOLOX 33	1.5.2/8.2	6-8	1.1740	C 60 W	1.5.1/8.2	6-8
-	TOOLOX 44	8.2.1	6-8	1.1744	C 67 W	1.5.1/8.2	6-8
-	Ultramit	7.1	6-8	1.1820	C 55 W	1.5.1/8.2	6-8
-	VANADIS 4	1.5.2/8.2	6-8	1.2080	X 210 Cr 12	1.5.2/8.2	6-8
-	VANADIS 10	1.5.2/8.2	6-8	1.2083	X 42Cr 13	1.5.4/8.2	6-8
0.6010	GG-10	2.1	6-8	1.2127	105 MnCr 4	1.5.2/8.2	6-8
0.6015	GG-15	2.1	6-8	1.2201	X 165 CrV 12	1.5.2/8.2	6-8
0.6020	GG-20	2.1	6-8	1.2303	100 CrMo 5	1.5.2/8.2	6-8
0.6025	GG-25	2.1	6-8	1.2309	65 MnCrMo 4	1.5.5/8.2	6-8
0.6030	GG-30	2.2	6-8	1.2311	40 CrMnMo 7	1.5.5/8.2	6-8
0.6035	GG-35	2.2	6-8	1.2312	40 CrMnMoS 8 6	1.5.4/8.2	6-8
0.6040	GG-40	2.2	6-8	1.2316	X 36CrMo 17	1.5.4/8.2	6-8
0.7033	GGG-35.3	2.3	6-8	1.2343	X 38CrMoV 5 1	1.5.5/8.2	6-8
0.7040	GGG-40	2.3	6-8	1.2344	X 40 CrMoV 5 1	1.5.5/8.2	6-8
0.7043	GGG-40.3	2.3	6-8	1.2363	X 100 CrMoV 5 1	1.5.2/8.2	6-8
0.7050	GGG-50	2.3	6-8	1.2367	X 38 CrMoV 5 3	1.5.5/8.2	6-8
0.7060	GGG-60	2.3	6-8	1.2379	X155 CrMoV 12 1	1.5.2/8.2	6-8
0.8035	GTW-35-04	2.3	6-8	1.2436	X 210 CrW 12	1.5.2/8.2	6-8
0.8040	GTW-40-05	2.3	6-8	1.2601	X 165 CrMoV 12	1.5.2/8.2	6-8
0.8045	GTW-45-07	2.3	6-8	1.2622	X 60 WCrMoV 9 4	1.5.5/8.2	6-8
0.8055	GTW-55	2.3	6-8	1.2678	X 45 CrCoWV 5 5 5	1.5.5/8.2	6-8
0.8065	GTW-65	2.3	6-8	1.2731	X 50 NiCrWV 13 13	1.5.5/8.2	6-8
0.8135	GTS-35-10	2.3	6-8	1.2767	X 45 NiCrMo 4	1.5.5/8.2	6-8
0.8145	GTS-45-06	2.3	6-8	1.2842	90 MnCrV 8	1.5.2/8.2	6-8
0.8155	GTS-55-04	2.3	6-8	1.2880	X 165 CrCoMo 12	1.5.2/8.2	6-8
0.8165	GTS-65-02	2.3	6-8	1.2884	X 210 CrCoW 12	1.5.2/8.2	6-8
1.0035	St 33	1.1.1	6-8	1.2889	X 45 CoCrMoV 5 5 3	1.5.5/8.2	6-8
1.0037	St 37-2	1.1.1	6-8	1.2889	X 45 CoCrMoV 5 5 3	1.5.5/8.2	6-8
1.0044	St 44-2	1.1.1	6-8	1.3243	S 6-5-2-5	1.5.3/8.2	6-8
1.0050	St 50-2	1.1.1	6-8	1.3343	S 6-5-2	1.5.3/8.2	6-8
1.0060	St 60-2	1.1.1	6-8	1.3344	S 6-5-3	1.5.3/8.2	6-8
1.0070	St 70-2	1.1.1	6-8	1.3346	S 2-9-1	1.5.3/8.2	6-8
1.0116	St 37-3	1.1.1	6-8	1.3348	S 2-9-2	1.5.3/8.2	6-8
1.0120	St 37	1.1.1	6-8	1.3401	X 120 Mn 12	1.4.4	6-8
1.0140	St 42	1.1.1	6-8	1.3501	100 Cr 2 (W1)	1.4.2	6-8
1.0144	St 44-3	1.1.1	6-8	1.3503	105 Cr 4 (W2)	1.4.2	6-8
1.0181	St 42-2	1.1.1	6-8	1.3505	100 Cr 6 (W3)	1.4.2	6-8
1.0301	C 10	1.2.1	6-8	1.3520	100 CrMn 6 (W4)	1.4.2	6-8
1.0345	H I	1.1.2	6-8	1.3543	X 102 CrMo 17	1.4.2	6-8
1.0401	C 15	1.2.1	6-8	1.3956	X 8 CrNi 18 12	1.6.2	6-8
1.0402	C 22	1.2.2	6-8	1.4000	X 6 Cr 13	1.6.3	6-8
1.0420	GS-38	1.1.3	6-8	1.4002	X 6 CrAl 13	1.6.3	6-8
1.0425	H II	1.1.2	6-8	1.4005	X 12 CrS 13	1.6.5/8.2	6-8
1.0435	H III	1.1.2	6-8	1.4006	X 10 Cr 13	1.6.5/8.2	6-8
1.0443	GS-45	1.1.3	6-8	1.4008	G-X 8 CrNi 13	1.6.3	6-8
1.0445	H IV	1.1.2	6-8	1.4016	X 6 Cr 17	1.6.3	6-8
1.0461	StE 255	1.1.4	6-8	1.4021	X 20 Cr 13	1.6.5/8.2	6-8
1.0482	19 Mn 5	1.3.2	6-8	1.4024	X 15 Cr 13	1.6.5/8.2	6-8
1.0501	C 35	1.2.2	6-8	1.4027	G-X 20 Cr 14	1.6.3	6-8
1.0503	C 45	1.2.2	6-8	1.4028	X 30 Cr 13	1.6.5/8.2	6-8
1.0528	C 30	1.2.2	6-8	1.4034	X 46 Cr 13	1.6.5/8.2	6-8
1.0531	St 50	1.1.1	6-8	1.4057	X 20 CrNi 17 2	1.6.5/8.2	6-8

Werkstoffübersicht nach Werkstoffnummer (W.-Nr.)
 Work material overview according material-no. (W.-Nr.)
 Index-Gruppe de matières selon numéro (W.-Nr.)
 Materiali da lavorare secondo nr. materiale (W.-Nr.)

W.-Nr.	DIN (DE)	Werkstoffgruppen Classification of work materials Groupes de matières Gruppo materiali		W.-Nr.	DIN (DE)	Werkstoffgruppen Classification of work materials Groupes de matières Gruppo materiali	
1.4059	G-X 22 CrNi 17	1.6.3	6-8	2.0360	CuZn 40 (Ms60)	3.2	6-8
1.4104	X 12 CrMoS 17	1.6.1	6-8	2.0380	CuZn 39 Pb 2 (Ms58)	3.2	6-8
1.4105	X 4 CrMoS 18	1.6.1	6-8	2.0410	CuZn 44 Pb 2 (Ms 56)	3.2	6-8
1.4106	X 10 CrMo 13	1.6.5/8.2	6-8	2.0561	CuZn 40 Al 1	3.2	6-8
1.4112	X 90 CrMoV 18	1.6.5/8.2	6-8	2.0580	CuZn 40 Mn 1 Pb	3.2	6-8
1.4113	X 6 CrMo 17	1.6.3	6-8	2.0771	CuNi 7 Zn 39 Mn 5 Pb 3	3.2	6-8
1.4116	X 45 CrMoV 15	1.6.5/8.2	6-8	2.0916	CuAl 5 (AlBz 5)	3.4	6-8
1.4138	G-X 120 CrMo 29 2	1.6.5/8.2	6-8	2.0932	CuAl 8 Fe 3 (AlBz 8 Fe)	3.4	6-8
1.4300	X 12 CrNi 18 8	1.6.2	6-8	2.0966	CuAl 10 Ni 5 Fe 4	3.4	6-8
1.4301	X 5 CrNi 18 10	1.6.2	6-8	2.0978	CuAl 11 Ni 6 Fe 5	3.5	6-8
1.4305	X 10 CrNiS 18 9	1.6.1	6-8	2.1020	CuSn 6	3.3	6-8
1.4305	X 10 CrNiS 18 9	1.6.1	6-8	2.1030	CuSn 8	3.3	6-8
1.4308	X 6 CrNi 18 9	1.6.2	6-8	2.1050	G-CuSn 10 Zn (Rg 10)	3.2	6-8
1.4311	X 2 CrNiN 18 10	1.3.1	6-8	2.1080	CuSn 6 Zn 6	3.3	6-8
1.4312	G-X 10 CrNi 18 8	1.6.2	6-8	2.1086	G-CuSn 10	3.2	6-8
1.4406	X 2 CrNiMoN 17 12 2	1.3.1/1.6.2	6-8	2.1093	G-CuSn 6 ZnNi	3.2	6-8
1.4408	X 6 CrNiMo 18 10	1.6.2	6-8	2.1096	G-CuSn 5 ZnPb (Rg 5)	3.2	6-8
1.4410	X 3 CrNiMoN 25 7 4	1.6.2	6-8	2.1245	CuBe 1,7 F110	3.3/3.5/3.6	6-8
1.4433	X 2 CrNiMo 18 15	1.6.2	6-8	2.1247	CuBe 2	3.3/3.4/3.6	6-8
1.4435	X 2 CrNiMo 18 14 3	1.6.2	6-8	2.1293	CuCrZr	3.3	6-8
1.4460	X 8 CrNiMo 27 5	1.6.4	6-8	2.1356	CuMn 3	3.1	6-8
1.4510	X 6 CrTi 17	1.6.3	6-8	2.1504 LN	NiAlBz	6.1	6-8
1.4511	X 6 CrNb 17	1.6.3	6-8	2.1522	CuSi 2 Mn	3.1	6-8
1.4512	X 5 CrTi 12	1.6.3	6-8	2.1525	CuSi 3 Mn	3.3	6-8
1.4528	X 105 CrCoMo 18 2	1.6.3	6-8	2.4042	Ni 99 CSi	6.1	6-8
1.4536	G-X 2 NiCrMoCuN 25 20	1.6.2	6-8	2.4060	Ni 99,6	6.1	6-8
1.4541	X 6 CrNiTi 18 10	1.6.2	6-8	2.4062	Ni 99,4 Fe	6.1	6-8
1.4550	G-X 6 CrNiNb 18 10	1.6.2	6-8	2.4360	NiCu 30 Fe	6.2	6-8
1.4571	X 6 CrNiMoTi 17 12 2	1.6.2	6-8	2.4374 LN	-	6.2	6-8
1.4573	X 10 CrNiMoTi 18 12	1.6.2	6-8	2.4617	NiMo 28	6.2	6-8
1.4581	G-X 5 CrNiMoNb 18 10	1.6.2	6-8	2.4631	NiCr 20 TiAl	6.3	6-8
1.4582	X 4 CrNiMoNb 25 7	1.6.4	6-8	2.4632	NiCr 20 Co 18 Ti	6.3	6-8
1.4710	G-X 30 CrSi 6	1.6.6/8.2	6-8	2.4634	NiCo 20 Cr 15 MoAlTi	6.3	6-8
1.4712	X 10 CrSi 6	1.6.3	6-8	2.4662	-	6.3	6-8
1.4718	X 45 CrSi 9 3	1.6.6/8.2	6-8	2.4665	NiCr 22 Fe 18 Mo	6.2	6-8
1.4722	X 10 CrSi 13	1.6.3	6-8	2.4668	NiCr 19 FeNbMo	6.3	6-8
1.4729	G-X 40 CrSi 13	1.6.6/8.2	6-8	2.4670 LN	G - NiCr 13 Al 6 MoNb	6.3	6-8
1.4747	X 80 CrNiSi 20	1.6.6/8.2	6-8	2.4674 LN	NiCo 15 Cr 10 MoAlTi	6.3	6-8
1.4762	X 10 CrAl 24	1.6.3	6-8	2.4812	-	6.2	6-8
1.4821	X 20 CrNiSi 25 4	1.6.4	6-8	2.4816	NiCr 15 Fe	6.2	6-8
1.4825	G-X 25 CrNiSi 18 9	1.6.6/8.2	6-8	2.4856	NiCr 22 Mo 9 Nb	6.3	6-8
1.4848	G-X 40 CrNiSi 25 20	1.6.6/8.2	6-8	2.4876	-	6.2	6-8
1.4922	X 20 CrMoV 12 1	1.3.2	6-8	2.4983	NiCr 18 Co 18 MoTi	6.2	6-8
1.5022	38 Si 6	1.4.3	6-8	2.6554	-	6.3	6-8
1.5024	46 Si 7	1.4.3	6-8	3.0250	Al 99,5 H	4.1	6-8
1.5025	51 Si 7	1.4.3	6-8	3.0256	E-Al H	4.1	6-8
1.5142	60 SiMn 5	1.4.3	6-8	3.0280	Al 99,8 H	4.1	6-8
1.5404	21 MoV 53	1.3.2	6-8	3.0515	G-Al 99,5	4.2	6-8
1.5406	17 MoV 84	1.3.2	6-8	3.0516	S-AlMn	4.2	6-8
1.5622	14 Ni 6	1.3.1	6-8	3.0525	AlMn 1 Mg 0,5	4.2	6-8
1.5633	24 Ni 8	1.3.1	6-8	3.0615	AlMgSiPb	4.2	6-8
1.5919	GS-15 CrNi 6	1.3.5	6-8	3.1325	AlCuMg 1	4.2	6-8
1.5919	15 CrNi 6	1.4.6	6-8	3.1355	AlCuMg 2	4.2	6-8
1.7012	13 Cr 2 (EC30)	1.2.1	6-8	3.1841	G-AlCu 4 Ti	4.2	6-8
1.7015	15 Cr 3 (EC60)	1.2.1	6-8	3.2134	GD-AlSi 5 Cu 1 Mg	4.3	6-8
1.7103	67 SiCr 5	1.4.3	6-8	3.2152	GD-AlSi 6 Cu 4	4.3	6-8
1.7131	16 MnCr 5 (EC 80)	1.2.1/1.4.6	6-8	3.2162	GD-AlSi 8 Cu 3	4.3	6-8
1.7147	20 MnCr 5	1.4.6	6-8	3.2373	G-AlSi 9 Mg	4.3	6-8
1.7218	GS-25 CrMo 4	1.3.5	6-8	3.2381	G-AlSi 10 Mg	4.3	6-8
1.7218	25 CrMo 4	1.4.1	6-8	3.2383	G-AlSi 10 Mg (Cu)	4.4	6-8
1.7219	26 CrMo 4	1.3.1	6-8	3.2581	G-AlSi 12	4.4	6-8
1.7220	GS-34 CrMo 4	1.3.5	6-8	3.2583	G-AlSi 12 (Cu)	4.4	6-8
1.7220	34 CrMo 4	1.3.4/1.4.5	6-8	3.2982	GD-AlSi 12 (Cu)	4.4	6-8
1.7225	42 CrMo 4	1.3.4/1.4.5	6-8	3.3241	G-AlMg 3 Si	4.2	6-8
1.7228	50 CrMo 4	1.3.4/1.4.5	6-8	3.3292	GD-AlMg 9	4.2	6-8
1.7321	20 MoCr 4	1.4.6	6-8	3.3308	Al 99,9 Mg 0,5	4.1	6-8
1.7325	25 MoCr 4	1.4.6	6-8	3.3315	AlMg 1	4.2	6-8
1.7337	16 CrMo 4 4	1.3.2	6-8	3.3535	AlMg 3	4.2	6-8
1.7379	GS-18 CrMo 9 10	1.3.5	6-8	3.4365	AlZnMgCu 1,5	4.2	6-8
1.7701	51 CrMoV 4	1.4.3	6-8	3.5106	G-MgAg 3 SE 2 Zr 1	4.4	6-8
1.8070	21 CrMoV 5 11	1.3.2	6-8	3.5562	G-MgAl 6	4.4	6-8
1.8504	34 CrAl 6	1.3.3/1.4.7	6-8	3.5812	GD-MgAl 8 Zn 1	4.4	6-8
1.8506	34 CrAlSi 5	1.3.3	6-8	3.5912	GD-MgAl 9 Zn 1	4.4	6-8
1.8507	34 CrAlMo 5	1.4.7	6-8	3.7024.1 LN	Ti 99,5	5.1	6-8
1.8509	41 CrAlMo 7	1.4.7	6-8	3.7034.1 LN	Ti 99,7	5.1	6-8
1.8515	31 CrMo 12	1.3.3/1.4.7	6-8	3.7055	Ti 99,4	5.1	6-8
1.8519	31 CrMoV 9	1.3.3	6-8	3.7064.1 LN	Ti 99,2	5.1	6-8
1.8550	34 CrAlNi 7	1.3.3/1.4.7	6-8	3.7114 LN	TiAl 5 Sn 2	5.2	6-8
1.8905	StE 460	1.1.4	6-8	3.7124 LN	TiCu 2	5.2/5.3	6-8
1.8907	StE 500	1.1.4	6-8	3.7144 LN	TiAl 6 Sn 2 Zr 4 Mo 2	5.3	6-8
1.8931	StE 690 V	1.4.8	6-8	3.7154 LN	TiAl 6 Zr 5	5.3	6-8
1.8941	StE 960 V	1.4.8	6-8	3.7163 LN	TiAl 6 V 4	5.2	6-8
2.0060	E-Cu 57	3.1	6-8	3.7164 LN	TiAl 5 V 4	5.3	6-8
2.0070	SE-Cu	3.1	6-8	3.7164 LN	TiAl 6 V 4	5.3	6-8
2.0090	SF-Cu	3.1	6-8	3.7174 LN	TiAl 6 V 6 Sn 2	5.2/5.3	6-8
2.0250	CuZn 20 (Ms80)	3.3	6-8	3.7184 LN	TiAl 4 Mo 4 Sn 2	5.3	6-8
2.0265	CuZn 30 (Ms70)	3.3	6-8				
2.0321	CuZn 37	3.3	6-8				
2.0335	CuZn 36 (Ms63)	3.3	6-8				

Werkstoffgruppen · Classification of work materials · Groupes de matières · Gruppi materiali

W-Nr.	DIN (DE)	EN (EU)	NF A (FR)	BS (GB)	UNI (IT)	SS (SE)	UNE (ES)	SAE/ASTM (US)	JIS (JP)
1 Stähle – Steels – Aciers – Acciai									
1.1 Baustähle (Rm < 800 N/mm²) – Structural steels (tensile strength < 800 N/mm²) – Aciers de construction (résistance < 800 N/mm²) – Acciai da costruzione (resistenza < 800 N/mm²)									
1.1.1 Allgemeine Baustähle – General structural steels – Aciers mi-dur – Acciai per applicazioni generali									
1.0035	St 33	–	A 33	–	Fe 320	–	AE 235-B	–	–
1.0037	St 37-2	S 235 JRG 2	E 24-2NE	4360-40 C	Fe 360 B	1312	–	A 570 Grade 36	STKM 12 C
1.0044	St 44-2	S 275 JR	E 28-2	4360-43 B	Fe 430 BFN	1412	AE 275-B	A 570 Grade 40	–
1.0050	St 50-2	E 295	A 50-2	4360-50 B	Fe 490	2172	–	A 570 Grade 50	SS 50
1.0060	St 60-2	–	A 60-2	4360-55 E	Fe 590	–	–	–	SM 58
1.0070	St 70-2	–	A 70-2	–	Fe 70-2	–	A 690-2	–	–
1.0116	St 37-3	Fe 360 D1(2); S 235 J2G3(4)	Fe 360 D1(2); E 24-4	Fe 360 D1(2); 4360-40 D	Fe 360 D 1(2); Fe37-3	1313	Fe 360 D 1(2); A 360 C	A 573-81 65; Grade 58	–
1.0120	St 37	–	–	–	–	–	–	–	–
1.0140	St 42	–	–	–	–	–	–	–	–
1.0144	St 44-3	Fe 430 D1(2); S 275 J2 G3 (4)	Fe 430 D1(2); E 28-4	Fe 430 D1(2); 4360 43 D	Fe 430 D1(2)	1414	Fe 430 D 1(2)	A 573-81; Grade 70	SM 41 C
1.0181	St 42-2	–	–	–	–	–	–	–	–
1.0531	St 50	–	–	–	–	–	–	–	–
1.0570	St 52-3	Fe 510 D1; S 355 J 2 G 3	Fe 510 D1; E 36-4	Fe 510 D1; 4360-50 D	Fe 510 D1	2134-01	Fe 510 D 1	Grade 50	SM 520 C
1.1.2 Kesselbleche – Boiler plate – Tôles – Piastre per boiler									
1.0345	H I	P 235 GH	A 37 CP; CC 12	1501 161	–	1330	F.1110; A 37 RC 1	A 515 65	SGV 410, 450, 480, 490
1.0425	H II	P 265 GH	A 42 CP; XC 25	161-400	Fe 410 1 KW	1432	A 42 RC 1	–	SGV 410, 450, 480
1.0435	H III	P 285 NH	–	–	–	–	–	–	–
1.0445	H IV	P 295 NH	–	–	–	–	–	–	–
1.1.3 Stahlguss – Cast steel – Fonte d'acier -Acciai fusi									
1.0420	GS-38	GE 200	E 24-2 Ne	–	–	1306	–	–	–
1.0443	GS-45	–	230-400 M	A 1	–	1305	F.221	A 27 65-35	–
1.0552	GS-52	GE 260	AF 55 C 35	A 2	–	1505	–	A 27 70-36	–
1.0558	GS-60	GE 360; S 355J 0	AF 65 C 45; E 36-3	A 3; En 50 C	Fe 510	1606	–	A 148 80-40	–
1.1.4 Feinkornbaustähle – Fine-grain structural steel – Aciers frittés – Acciai a grana fina									
1.0461	StE 255	S 255 N	–	–	–	–	–	–	–
1.0582	StE 355	P 355 N	–	–	–	–	–	–	–
1.8905	StE 460	P 460 N	E 460 RIFP; S 460 N	–	–	–	AE 460 KG	A 633 Grade E	–
1.8907	StE 500	S 500 N	–	–	–	–	–	–	–
1.2 Unlegierte und niedriglegierte Stähle (Rm < 800 N/mm²) – Unalloyed and low-alloy steel (tensile strength < 800 N/mm²) – Aciers non alliés et faiblement alliés (résistance < 800 N/mm²) – Acciai non e debolmente legati (resistenza < 800 N/mm²)									
1.2.1 Einsatzstähle – Cementation steels – Aciers de cémentation – Acciai da cementazione									
1.0301	C 10	–	AF 34 C 10; XC 10	045 M 10	C 10	–	–	1010	S 10 C
1.0401	C 15	–	AF 37 C 12; XC 12	080 M 15	C 15; C 16	1350	F.111	1015	S 15 C
1.1121	Ck 10	2 C 10	C 10 E; XC 10	045 M 10	C 10	1265	F.1510 – C 10 k	1010	S 10 C
1.1140	Cm 15 (C 15 R)	C 15 R	C 15 R	C 15 R	C 15 R	C 15 R	–	–	–
1.1141	Ck 15	2 C 15	C 15 E; XC 12	080 M 15	C 16	1370	F.1511 – C 16 k	1015	S 15 C
1.7012	13 Cr 2 (EC30)	–	–	–	–	–	–	–	–
1.7015	15 Cr 3 (EC60)	–	12 C 3	523 M 15	–	–	–	5015	ScR 415 (H)
1.7131	16 MnCr 5 (EC 80)	16 MnCr 5	16 MC 5; 15 D 3	527 M 17	16 MnCr 5	2511	F.1515 – 16 MnCr 5	5115	ScR 415
1.2.2 Vergütungsstähle – Heat-treatable steels – Aciers d'amélioration – Acciai da bonifica									
1.0402	C 22	1 C 22	AF 42 C 20; XC 25	050 A 20	C 20; C 21	1450	F.112	1020	S 22 C
1.0501	C 35	1 C 35	AF 55 C 35; XC 38	060 A 35	C 35	1550	F.113	1035	S 35 C
1.0503	C 45	1 C 45	AF 65 C 45; CC 45	080 M 46	C 45	1650	F.114; F.5110	1043; 1045	S 45 C
1.0528	C 30	1 C 30	AF 50 C 30; CC 32	080 M 30	C 30	–	–	1030	S 30 C
1.1151	Ck 22	2 C 22	C 22 E; XC 25	050 A 20; 070 M 20	C 20	–	F.1120 – C 25 k	1023; 1020	S 22 C
1.1178	Ck 30	2 C 30	C 30 E; XC 32	080 M 30	C 30	–	–	1030	S 30 C
1.1180	Cm 35	3 C 35	C 35 R; XC 32	080 M 36	–	1572-03/04	F.1135 – C 35 K – 1	–	–
1.1181	Ck 35	2 C 35	C 35 E; XC 38 H 1; 320-560 M	080 A 32; 080 M 36	C 35	1572	F.1135 – C 35 k	1035	S 35 C
1.1191	Ck 45	2 C 45	C 45 E; XC 42 H 1; XC 45	080 M 46	C 45	1672	F.1140 – C 45 k	1042; 1045	S 45 C
1.2.3 Automatenstähle – Free cutting steels – Aciers de décolletage – Acciai automatici									
1.0710	15 S 10	–	–	–	–	–	–	–	–
1.0715	9 SMn 28	11 SMn 28	S 250	230 M 07	CF 9 SMn 28	1912	F.2111 – 11 SMn 28	1213	SUM 22
1.0718	9 SMnPb 28	11 SMnPb 28	S 250 Pb; 35 MF 4	–	CF 9 SMnPb 28	1914	F.2112 – 11 SMnPb 28	12 L13	SUM 22 L
1.0721	10 S 20	10 S 20	10 F 1	210 M 15	CF 10 S 20	–	F.2121 – 10 S 20	1108	–
1.0722	10 SPb 20	10 SPb 20	10 Pb F 2	–	CF 10 SPb 20	–	F.2122 – 10 SPb 20	11 L 08	–
1.0723	15 S 20	–	S 300	210 A 15	–	1922	F.210.F	–	SUM 32
1.0726	35 S 20	35 S 20	35 MF 4	212 M 36	–	1957	F.210 G	1140	–
1.0727	45 S 20	45 S 20	45 MF 4	212 M 44	–	1973	–	1146	–
1.0736	9 SMn 36	–	S 300	240 M 07	CF 9 SMn 36	–	F.2113 – 12 SMn 35	1215	–
1.0737	9 SMnPb 36	–	S 300 Pb	–	CF 9 SMnPb 36	1926	F.2114 – 12 SMnPb 35	12 L14	–
1.2.4 Kaltfließpressstähle – Cold flow press steels – Aciers pour extrusion à froid – Acciai estrusi a freddo									
1.1132	Cq 15	C 15 KD	C 15 C	C15E2C	C15E2C	C15E2C	–	–	SWRCH15K
1.1152	Cq 22	C 21 KD	C 22 C	C20E2C	C20E2C	C20E2C	–	–	SWRCH20K
1.1172	Cq 35	C 35 KD	C 35 C	–	–	–	–	–	–
1.1192	Cq 45	C 45 KD	C 45 C	C45EC	C45EC	C45EC	–	–	SWRCH45K
1.3 Legierte Stähle (Rm < 800 N/mm²) – Alloyed steel (tensile strength < 800 N/mm²) – Aciers alliés (résistance < 800 N/mm²) – Acciai legati (resistenza < 800 N/mm²)									
1.3.1 Kaltzähle Baustähle – Cold-tough structural steels – Aciers alliés pour l'usage à froid – Acciai per l'uso a freddo									
1.1169	20 Mn 6	–	–	–	–	–	–	–	–
1.4311	X 2 CrNiN 18 10	X 2 CrNiN 18 10	Z 2 CN 18-10 AZ	304 S 62	X 2 CrNiN 18 11	2371	F.3541	304 LN	SUS 304 LN
1.4406	X 2 CrNiMoN 17 12 2	X 3 CrNiMoN 17 12 2	Z 3 CNd 17-12 AZ	316 S 61	X 2 CrNiMoN 17 12	2375	F.3543	316 LN	SUS 316 LN
1.5622	14 Ni 6	–	16 N 6	–	14 Ni 6	–	F.2641 – 15 Ni 6	A 350 – LF 5	–
1.5633	24 Ni 8	–	22 N 8	–	–	–	–	–	–
1.7219	26 CrMo 4	–	25 CD 4 S	–	–	–	–	–	–

Werkstoffgruppen · Classification of work materials · Groupes de matières · Gruppi materiali

W-Nr.	DIN (DE)	EN (EU)	NF A (FR)	BS (GB)	UNI (IT)	SS (SE)	UNE (ES)	SAE/ASTM (US)	JIS (JP)
1.3.2 Warmfeste Baustähle – Heat resistant structural steels – Aciers réfractaires – Acciai resistenti al calore									
1.0482	19 Mn 5	P 335 GH	A 52 CP; AP; FP	224-460	-	2101	A 47 RB II	A 537	-
1.4922	X 20 CrMoV 12 1	-	X 20 CrMoV 11 1	762	X 20 CrMoNi 12 01 KG	2317	-	-	-
1.5404	21 MoV 53	-	-	-	-	-	-	-	-
1.5406	17 MoV 84	-	-	-	-	-	-	-	-
1.7337	16 CrMo 4.4	-	15 CD 4.5	1501 620 Gr. 27	14 CrMo 4 5	2216	-	A 387 12 Cl.2	-
1.8070	21 CrMoV 5 11	-	-	-	-	-	-	-	-
1.3.3 Nitrierstähle – Nitriding alloy steels – Aciers de nitruration – Acciai da nitrurazione									
1.8504	34 CrAl 6	-	-	-	-	-	-	-	-
1.8506	34 CrAlS 5	-	-	-	-	-	-	-	-
1.8515	31 CrMo 12	31 CrMo 12	30 CD 12	722 M 24	31 CrMo 12	2240	F.1712 – 31 CrMo 12	-	-
1.8519	31 CrMoV 9	-	40 CAD 6.12	-	-	-	-	-	-
1.8550	34 CrAlNi 7	-	-	-	-	-	-	-	-
1.3.4 Vergütungsstähle – Heat-treatable steels – Aciers d'amélioration – Acciai da bonifica									
1.1133	20 Mn 5	-	20 M 5	120 M 19	G 22 Mn 3	1410	F-1515	1022; 1518	SMnC 420
1.1157	40 Mn 4	-	35 M 5, 40 M 5	150 M 36	-	-	-	1039	-
1.1170	28 Mn 6	-	20 M 5	150 M 28	C 28 Mn	-	-	1330	SCMn 1
1.7220	34 CrMo 4	34 CrMo 4	34 CD 4	708 A 37	35 CrMo 4	2234	F.8231-AM – 34 CrMo 4	4137; 4135	SCM 432; SCM 435
1.7225	42 CrMo 4	42 CrMo 4	42 CD 4; 42 C 4 TS	708 M 40	42 CrMo 4	2244	F.8232 – 42 CrMo 4	4140; 4142	SCM 440
1.7228	50 CrMo 4	50 CrMo 4	-	708 A 47	50 CrMo 4	-	50 CrMo 4	4150	SCM 445 (H)
1.3.5 Stahlguss – Cast steel – Fonte d'acier – Acciaio fuso									
1.5919	GS-15 CrNi 6	-	16 NC 6	S 107	16 CrNi 4	-	-	-	-
1.7218	GS-25 CrMo 4	25 CrMo 4	25 CD 4	708 A 25; CDS 110	25 CrMo 4	2225	F.8330-AM – 25 CrMo 4	4130	SCM 420; SCM 430
1.7220	GS-34 CrMo 4	34 CrMo 4	34 CD 4	708 A 37	35 CrMo 4	2234	F.8231-AM – 34 CrMo 4	4137; 4135	SCM 432; SCM 435
1.7379	GS-18 CrMo 9 10	-	-	-	-	-	-	-	-
1.4 Legierte, vergütete Stähle (Rm 800–1200 N/mm²) – Alloyed, Pre hardened steels (tensile strength 800–1200 N/mm²) – Aciers alliés, améliorés (résistance 800–1200 N/mm²) – Acciaio legato , pre trattato (resistenza 800–1200 N/mm²)									
Legierte, vergütete Stähle (kurzspanend) – Alloyed, Pre hardened steels (short chipping) – Aciers alliés, dureté entre (laitons) – Acciaio legato , pre trattato a truciolo corto									
1.4.1 Vergütungsstähle – Heat-treatable steels – Aciers d'amélioration – Acciai da bonifica									
1.1133	20 Mn 5	-	20 M 5	120 M 19	G 22 Mn 3	1410	F-1515	1022; 1518	SMnC 420
1.1157	40 Mn 4 V	-	35 M 5, 40 M 5	150 M 36	-	-	-	1039	-
1.1170	28 Mn 6 V	-	35 M 5, 20 M 5	150 M 28	C 28 Mn	-	-	1330	SMn 433
1.7218	25 CrMo 4	25 CrMo 4	25 CD 4	708 A 25	25 CrMo 4	2225	F.8330-AM – 25 CrMo 4	4130	SCM 420; SCM 430
1.4.2 Wälzlagerstähle – Roller and ball bearing steels – Aciers laminés – Acciai per cuscinetti									
1.3501	100 Cr 2 (W1)	-	-	-	-	-	-	-	-
1.3503	105 Cr 4 (W2)	-	-	-	-	-	-	E 51100	-
1.3505	100 Cr 6 (W3)	100 Cr 6	100 C 6; 20 NCD 2	534 A 99	100 Cr 6	2258	F.1310 – 100 Cr 6	52100	SUJ 2, SUJ 4
1.3520	100 CrMn 6 (W4)	100 CrMn 6	100 CM 6	-	-	-	100 CrMn 6	A 485/2	SUJ 3
1.3543	X 102 CrMo 17	-	-	-	X 105 CrMo 17	-	X 100 CrMo 17	-	-
1.4.3 Federstähle – Spring steels – Aciers à ressort – Acciai per molle									
1.5022	38 Si 6	-	-	-	-	-	-	-	-
1.5024	46 Si 7	-	-	-	-	-	-	-	-
1.5025	51 Si 7	-	-	-	51 Si 7	-	-	-	-
1.5142	60 SiMn 5	-	-	-	-	-	-	-	-
1.7103	67 SiCr 5	-	60 CS 7	-	67 SiCr 5	-	-	-	-
1.7701	51 CrMoV 4	-	51 CDV 4	-	51 CrMoV 4	-	-	-	-
1.4.4 Verschleißfeste Stähle – Wear resisting steels – Aciers résistant à l'usure – Acciai resistenti all'usura									
1.3401	X 120 Mn 12	-	Z 120 M 12	BW 10	X G 120 Mn 12	2183	F.82551-AM – X 120 Mn 12	A 128 75	SCMnH 1
-	HARDOX 400	-	-	-	-	-	-	-	-
Legierte, vergütete Stähle (langspanend) – Alloyed, Pre hardened steels (long chipping) – Aciers alliés, dureté entre (à copeaux longs) – Acciaio legato , pre trattato a truciolo lungo									
1.4.5 Vergütungsstähle – Heat-treatable steels – Aciers d'amélioration – Acciai da bonifica									
1.7220	34 CrMo 4	34 CrMo 4	34 CD 4	708 A 37	35 CrMo 4	2234	F.8231-AM – 34 CrMo 4	4137; 4135	SCM 432; SCM 435
1.7225	42 CrMo 4	42 CrMo 4	42 CD 4; 42 C 4 TS	708 M 40	42 CrMo 4	2244	F.8232 – 42 CrMo 4	4140; 4142	SCM 440
1.7228	50 CrMo 4	50 CrMo 4	-	708 A 47	50 CrMo 4	-	50 CrMo 4	4150	SCM 445 (H)
1.4.6 Einsatzstähle – Cementation steels – Aciers de cémentation – Acciai da cementazione									
1.7131	16 MnCr 5 (EC 80)	16 MnCr 5	16 MC 5; 15 D 3	527 M 17	16 MnCr 5	2511	F.1515 – 16 MnCr 5	5115	SCr 415
1.7147	20 MnCr 5	-	20 MC 5	-	20 MnCr 5	2523	F.150.D	5120	SMnC 420 (H)
1.7321	20 MoCr 4	20 MoCr 4	-	-	16 NiCrMo 2	2506	-	8620	SNMC 220
1.7325	25 MoCr 4	-	-	-	20 NiCrMo 2	-	-	8625	-
1.5919	15 CrNi 6	-	16 NC 6	S 107	16 CrNi 4	-	-	-	-
1.4.7 Nitrierstähle – Nitriding alloy steels – Aciers de nitruration – Acciai da nitrurazione									
1.8504	34 CrAl 6	-	-	-	-	-	-	-	-
1.8507	34 CrAlMo 5	34 CrAlMo 5	30 CAD 6.12	905 M 31	34 CrAlMo 7	-	F.1741 – 34 CrAlMo 5	A 355 Cl. D	-
1.8509	41 CrAlMo 7	41 CrAlMo 7	40 CAD 6.12; Z 8 C 13	905 M 39	41 CrAlMo 7	2940	F.1740 – 41 CrAlMo 7	A 355 Cl. A	SACM 645
1.8515	31 CrMo 12	31 CrMo 12	30 CD 12	722 M 24	31 CrMo12	2240	F.1712 – 31 CrMo 12	-	-
1.8550	34 CrAlNi 7	34 CrAlNi 7	-	-	-	-	-	A 355 Cl. C	-
1.4.8 Feinkornbaustähle – Fine-grain structural steels – Aciers frittés – Acciai a grana fina									
1.8931	StE 690 V	-	-	-	-	-	-	-	-
1.8941	StE 960 V	-	-	-	-	-	-	-	-

Werkstoffgruppen · Classification of work materials · Groupes de matières · Gruppi materiali

W-Nr.	DIN (DE)	EN (EU)	NF A (FR)	BS (GB)	UNI (IT)	SS (SE)	UNE (ES)	SAE/ASTM (US)	JIS (JP)
2.1050	G-CuSn 10 Zn (Rg 10)	-	-	G 1	-	-	-	C 90500	-
2.1086	G-CuSn 10	-	-	CT 1	-	-	-	C 90250	-
2.1093	G-CuSn 6 ZnNi	-	-	LG 4	-	-	-	C 92410	-
2.1096	G-CuSn 5 ZnPb (Rg 5)	-	CuPb 5 Sn 5 Zn 5	LG 2	-	-	-	C 83600	-
3.3 Kupferlegierungen (langspannend) – Copper alloys (long chipping) – Alliages de cuivre (à copeaux longs) – Leghe di Rame a truciolo lungo									
2.0250	CuZn 20 (Ms80)	-	-	CZ 103	OT 80	-	-	C 24000	-
2.0265	CuZn 30 (Ms70)	-	CuZn 30	CZ 106	OT 70	-	-	C 26000	-
2.0321	CuZn 37	-	CuZn 37	CZ 108	C 2720	-	-	C 27400	-
2.0335	CuZn 36 (Ms63)	-	CuZn 36	-	OT 63	-	-	C 27000	-
2.1020	CuSn 6	-	-	-	-	-	-	-	-
2.1030	CuSn 8	-	-	-	-	-	-	-	-
2.1080	CuSn 6 Zn 6	-	-	-	-	-	-	-	-
2.1245	CuBe 1,7	-	CuBe 1,7	CB 101	-	-	-	C 17000	-
2.1247	CuBe 2	-	CuBe 1,9	-	-	-	-	C 17200	-
2.1293	CuCrZr	-	UC 1 Zr	CC 102	-	-	-	C 18100	-
2.1525	CuSi 3 Mn	-	-	-	-	-	-	-	-
3.4 Kupfer-Sonderlegierungen (< 200 HB) – Copper alloys (< 200 HB) – Alliages de cuivre (< 200 HB) – Leghe di Rame speciali (< 200 HB)									
2.0916	CuAl 5 (AlBz 5)	-	-	-	-	-	-	-	-
2.0932	CuAl 8 Fe 3 (AlBz 8 Fe)	-	CuAl 7 Fe 2	CA 106	-	-	-	C 61400	-
2.0966	CuAl 10 Ni 5 Fe 4	-	CuAl 9 Ni 5 Fe 3 Mn; U-A 10 N	CA 104	-	-	-	C 63200	-
2.1247	CuBe 2 Fe 40	-	CuBe 1,9	-	-	-	-	C 17200	-
-	AMPCO 8	-	-	-	-	-	-	-	-
-	AMPCO 12	-	-	-	-	-	-	-	-
-	AMPCO 15	-	-	-	-	-	-	-	-
-	AMPCO 16	-	-	-	-	-	-	-	-
3.5 Kupfer-Sonderlegierungen (200 HB – 300 HB) – Copper alloys (200 HB – 300 HB) – Alliages de cuivre (200 –300HB) – Leghe di Rame speciali (200 HB – 300 HB)									
2.0978	CuAl 11 Ni 6 Fe 5	-	CuAl 11 Ni 6 Fe 5	-	-	-	-	-	-
2.1245	CuBe 1,7 F55	-	CuBe 1,7	CB 101	-	-	-	C 17000	-
-	AMPCO 18	-	-	-	-	-	-	-	-
-	AMPCO 20	-	-	-	-	-	-	-	-
3.6 Kupfer-Sonderlegierungen (> 300 HB) – Copper alloys (> 300 HB) – Alliages de cuivre (> 300 HB) – Leghe di Rame speciali (> 300 HB)									
2.1245	CuBe 1,7 F110	-	CuBe 1,7	CB 101	-	-	-	C 17000	-
2.1247	CuBe 2 F125	-	CuBe 1,9	-	-	-	-	C 17200	-
-	AMPCO 21	-	-	-	-	-	-	-	-
-	AMPCO 22	-	-	-	-	-	-	-	-
-	AMPCO 25	-	-	-	-	-	-	-	-
-	AMPCO 26	-	-	-	-	-	-	-	-
4 Aluminium / Aluminiumlegierungen – Aluminium / Aluminium alloys – Aluminium / Alliages d' aluminium – Alluminio / Leghe di Alluminio									
4.1 Aluminium (unlegiert, niedriglegiert) – Aluminium – Aluminium (non allie-faiblement allié) – Alluminio non e debolmente legato									
3.0250	Al 99,5 H	-	A 59050 C	1 B; L31 / 34 / 36	-	144007	L-3051	1050 A	-
3.0256	E-Al H	-	A 5 / L	1 E	-	144008	L-3052	1350 A	-
3.0280	Al 99,8 H	-	A 8	1 A	-	144004	L-3081	1080 A	-
3.3308	Al 99,9 Mg 0,5	-	A-9-G 0,5	-	-	-	-	-	-
4.2 Aluminium-Legierungen (< 0,5% Si) – Aluminium alloys (< 0,5% Si) – Alliages d'aluminium (< 0,5% Si) – Leghe di Alluminio (< 0,5% Si)									
3.0515	G-Al 99,5	-	3103	N 3	3568	144054	L 3811	3103	-
3.0516	S-AlMn	-	-	NG 3	-	144055	-	-	-
3.0525	AlMn 1 Mg 0,5	-	A – M 1 G 0,5	-	-	-	-	3005	A 3005
3.0615	AlMgSiPb	-	6262	-	-	-	L 3452	6012	-
3.1325	AlCuMg 1	AW-2017 A	A – U 4 G	H 14	3579	-	L-3120	2017 A	A 2017
3.1355	AlCuMg 2	AW-2024	A – U 4 G 1	2 L 98	3583	-	L-3140	2024	A 2024
3.1841	G-AlCu 4 Ti	-	-	2 L 91/92	3044	-	-	-	A C 1 A
3.3241	G-AlMg 3 Si	-	A-G 3 T	-	-	-	L 2341	511	-
3.3292	GD-AlMg 9	-	-	-	-	-	-	-	-
3.3315	AlMg 1	AW-6082	A – G 0,6	N 41	5764	144106	L-3350	5005 A	A 5005
3.3535	AlMg 3	-	A – G 3 M	N 5	3575	144133	L-3390	5754	-
3.4365	AlZnMgCu 1,5	-	A – Z 5 GU	2 L 95	3735	-	L-3710	7075	A 7075
4.3 Aluminium-Legierungen (0,5% – 10% Si) – Aluminium alloys (0,5% – 10% Si) – Alliages d'aluminium (0,5% – 10% Si) – Leghe di Alluminio (0,5% – 10% Si)									
3.2134	GD-AISI 5 Cu 1 Mg	-	A – S 4 Gu	LM 16	3600	-	L-2571	355,1	A C 4 D
3.2152	GD-AISI 6 Cu 4	-	A – S 5 U	LM 4 – LM 22	-	4230	L-2660	319,2	-
3.2162	GD-AISI 8 Cu 3	-	A – S 9 U 3	LM 24	-	4252	L-2630	380,1	-
3.2373	G-AISI 9 Mg	-	A 7 – S 10 G	-	3051	4235	-	-	A C 4 A
4.4 Aluminium-Legierungen (10% – 15% Si) – Aluminium alloys (10% – 15% Si) – Alliages d'aluminium (10% – 15% Si) – Leghe di Alluminio (10% – 15% Si)									
3.2381	G-AISI 10 Mg	-	A – S 10 G	LM 9	-	4253	L-2560	A 360	-
3.2383	G-AISI 10 Mg (Cu)	-	A – S 10 UG	LM 9	-	4253	-	A 360,2	A D C 3
3.2581	G-AISI 12	-	A – S 13	LM 6	4514	4261	L-2520	A 413,2	A C 3 A
3.2583	G-AISI 12 (Cu)	-	A – S 12 U	LM 20	3048	4260	L-2530	A 413,1	A D C 1
3.2982	GD-AISI 12 (Cu)	-	-	-	-	-	-	-	-
3.5106	G-MgAg 3 SE 2 Zr 1	MCMgRE 2 Ag 2 Zr	G-Ag 22,5	MAG 12	-	-	-	QE 22	-
3.5562	G-MgAl 6	-	-	-	-	-	-	-	-
3.5812	GD-MgAl 8 Zn 1	MCMgAl 8 Zn 1	G-A 9	MAG 1	AZ 81 hp	AZ 81 hp	AZ 81 hp	AZ 81	AZ 81 hp
3.5912	GD-MgAl 9 Zn 1	MCMgAl 9 Zn 1	G-A 9 Z 1	MAG 7	AZ 91 hp	-	-	AZ 91	-
4.5 Aluminium-Legierungen (> 15% Si) – Aluminium alloys (> 15% Si) – Alliages d'aluminium (> 15% Si) – Leghe di Alluminio (> 15% Si)									
-	G-AISI 17 Cu 4	-	-	-	-	-	-	390	-
-	G-AISI 21 CuNiMg	-	-	LM 28	-	-	-	-	-
-	G-AISI 25 CuNiMg	-	-	LM 29	-	-	-	393	-

Werkstoffgruppen · Classification of work materials · Groupes de matières · Gruppi materiali

W-Nr.	DIN (DE)	EN (EU)	NF A (FR)	BS (GB)	UNI (IT)	SS (SE)	UNE (ES)	SAE/ASTM (US)	JIS (JP)
5 Titan / Titanlegierungen – Titanium / Titanium alloys – Titane / Alliages de titane – Titanio / Leghe di Titanio									
5.1 Reintitan – Pure titanium – Titane pur – Titanio puro									
3.7024.1 LN	Ti 99,5	-	T-60	TA-6 / 7 / 8 / 9	-	-	Ti-PO4	4901 / 21	-
3.7034.1 LN	Ti 99,7	-	T-40	TA-2 / 3 / 4 / 5	-	-	Ti-PO2	4941 / 42 / 51 / 4902	-
3.7055	Ti 99,4	-	T-50	TA 3	-	-	-	R 50550	-
3.7064.1 LN	Ti 99,2	-	T-60	2 TA-6 / 7 / 8 / 9	-	-	-	-	-
5.2 Titanlegierungen (Rm < 900 N/mm²) – Titanium alloys (tensile strength < 900 N/mm²) – Alliages de titane (résistance < 900 N/mm²) – Leghe di Titanio (resistenza < 900 N/mm²)									
3.7114 LN	TiAl 5 Sn 2	-	-	-	-	-	-	-	-
3.7124 LN	TiCu 2	-	T-U 2	2 TA.21-24; TA.52-55 / 58	-	-	Ti-P11	-	-
3.7163 LN	TiAl 6 V 4	-	T-A 6 V	TA.10-13 / 28 / 56	-	-	Ti-P63	491128 / 35 / 54 / 65 / 67	-
3.7174 LN	TiAl 6 V 6 Sn 2	-	-	-	-	-	-	-	-
5.3 Titanlegierungen (Rm 900 – 1500 N/mm²) – Titanium alloys (tensile strength 900 – 1500 N/mm²) – Alliages de titane (résistance 900 – 1500 N/mm²) – Leghe di Titanio (resistenza 900 – 1500 N/mm²)									
3.7124 LN	TiCu 2	-	T-U 2	2 TA.21-24; TA.52-55 / 58	-	-	Ti-P11	-	-
3.7144 LN	TiAl 6 Sn 2 Zr 4 Mo 2	-	-	-	-	-	-	-	-
3.7154 LN	TiAl 6 Zr 5	-	T-A 6 ZD	TA.43 / 44	-	-	Ti-P67	-	-
3.7164 LN	TiAl 5 V 4	-	-	-	-	-	-	-	-
3.7164 LN	TiAl 6 V 4	-	T-A 6 V	TA.10-13 / 28 / 56	-	-	Ti-P63	491128 / 35 / 54 / 65 / 67	-
3.7174 LN	TiAl 6 V 6 Sn 2	-	-	-	-	-	-	-	-
3.7184 LN	TiAl 4 Mo 4 Sn 2	-	T-A 4 DE	TA.45-51 / 57	-	-	Ti-P68	-	-
6 Nickel / Nickellegierungen – Nickel / Nickel alloys – Nickel / Alliages de nickel – Nickel / Leghe di Nickel									
6.1 Reinnickel – Pure nickel – Nickel pur – Nickel puro									
2.1504 LN	NiAlBz	-	-	-	-	-	-	-	-
2.4042	Ni 99 CSi	-	-	-	-	-	-	-	-
2.4060	Ni 99,6	-	-	NA 46	-	-	-	-	-
2.4062	Ni 99,4 Fe	-	-	-	-	-	-	-	-
6.2 Nickellegierungen (Rm < 900 N/mm²) – Nickel alloys (tensile strength < 900 N/mm²) – Alliages de Nickel (résistance < 900 N/mm²) – Leghe di Nickel (resistenza < 900 N/mm²)									
2.4360	NiCu 30 Fe	Monel 400	NU 30	NA 13	-	-	-	N 04400	-
2.4374 LN	-	Monel 500	-	-	-	-	-	-	-
2.4617	NiMo 28	Hastelloy B 2	NiMo 28	NA 14	-	-	-	N 10665	-
2.4665	NiCr 22 Fe 18 Mo	Hastelloy X	NC 22 FeD	HR 6 / 204	-	-	MH-03	5536E	-
2.4812	-	Hastelloy C	-	-	-	-	-	-	-
2.4816	NiCr 15 Fe	Inconel 600	NC 15 Fe	NA 14	-	-	-	5540	NCF 600
2.4876	-	Inconel 800	-	-	-	-	-	-	-
2.4983	NiCr 18 Co 18 MoTi	Inconel 500	NCK 19 DAT	-	-	-	-	684	-
6.3 Nickellegierungen (Rm 900 – 1500 N/mm²) – Nickel alloys (tensile strength 900 – 1500 N/mm²) – Alliages de Nickel (résistance 900 – 1500 N/mm²) – Leghe di Nickel (resistenza 900 – 1500 N/mm²)									
2.4631	NiCr 20 TiAl	Nimonic 80A	NC 20 TA	HR 401	-	-	MH-07	-	NCF 80 A
2.4632	NiCr 20 Co 18 Ti	Nimonic 90	-	BA 19	-	-	-	-	-
2.4634	NiCo 20 Cr 15 MoAlTi	Nimonic 105	NCKD 20 ATV	HR 3 / 5007	-	-	MH-14	-	-
2.4662	-	Nimonic 901	Z 8 NCDT 42	MH 16	-	-	MH-16	5660 C	-
2.4668	NiCr 19 FeNbMo	Inconel 718	NC 19 Fe Nb	HR 8	-	-	MH-06	N 07718	NCF 718
2.4670 LN	G – NiCr 13 Al 6 MoNb	Nimocast 713	NC 13 AD	HC 203	-	-	MH-31	5391 A	-
2.4674 LN	NiCo 15 Cr 10 MoAlTi	Nimocast PK24	NK 15 CAT	HC 204	-	-	-	5397	-
2.4856	NiCr 22 Mo 9 Nb	Inconel 625	NC 22 FeDNB	NA 21	-	-	-	5581 / N 06625	NCF 625
2.6554	-	Waspaloy	-	-	-	-	-	-	-
7 Kunststoffe – Plastics – Plastiques – Materie plastiche									
7.1 Thermoplaste – Thermoplastics – Thermoplastiques – Termoplastiche									
-	Ultramit	-	-	-	-	-	-	-	-
-	Makralon	-	-	-	-	-	-	-	-
-	Hostalen	-	-	-	-	-	-	-	-
-	Degolan	-	-	-	-	-	-	-	-
-	Polystyrol	-	Polystyrène	Styrene	-	-	-	-	-
-	Hostaform	-	-	-	-	-	-	-	-
7.2 Duroplaste und Pressstoffe – Thermosetting polymers and pressed materials – Duroplastiques – Polimeri termoindurenti e materiali pressati									
-	Bakelit	-	-	-	-	-	-	-	-
-	Pertinax	-	-	-	-	-	-	-	-
-	Ferrozell	-	-	-	-	-	-	-	-
-	Resopal	-	Résopal – Formica	Formica	-	-	-	-	-
-	Albanit	-	-	-	-	-	-	-	-
7.3 Faserverstärkte Kunststoffe – Reinforced plastics – Matières synthétiques, renforcées par des fibres de verre – Plastiche rinforzate									
-	CFK Kohlefaserverstärkt	-	-	-	-	-	-	-	-
-	GFK Glasfaserverstärkt	-	-	-	-	-	-	-	-
-	AFK Aramidfaserverstärkt	-	-	-	-	-	-	-	-
8 Hartstoffe – Hardened materials – Matières dures (trempées) – Materiali duri									
8.1 Metallekeramiken – Metal ceramics – Matières dures, à base céramique – Materiali a base ceramica									
-	Ferrotic	-	-	-	-	-	-	-	-
-	Ferrotitanit	-	-	-	-	-	-	-	-
8.2 Gehärtete Stähle der Werkstoffgruppen 1.5 und 1.6.2 (50 – 65 HRC) – Hardened steels of groups 1.5 and 1.6.2 (50 – 65 HRC) – Aciers traités des groupes de matières 1.5 et 1.6.2 (50 – 65 HRC) – Acciai temprati del gruppo di materiali 1.5 e 1.6.2 (50-65 HRC)									
8.2.1 45 – 55 HRC									
-	HARDOX 500	-	-	-	-	-	-	-	-
-	TOOLOX 44	-	-	-	-	-	-	-	-
8.2.2 55 – 60 HRC									
8.2.3 60 – 65 HRC									

Kurzzeichenerklärung
Explication des symboles

Explanation of symbols
Spiegazione dei simboli

M	Metrisches ISO-Regelgewinde DIN 13 ISO Metric coarse thread DIN 13 Filetage métrique ISO DIN 13 Metrica ISO-passo grosso DIN 13
MF	Metrisches ISO-Feingewinde DIN 13 ISO Metric fine thread DIN 13 Filetage métrique fin DIN 13 Metrica ISO-passo fine DIN 13
G	Whitworth-Rohrgewinde DIN ISO 228 Whitworth pipe thread DIN ISO 228 Filetage Whitworth Gaz ISO 228 Whitworth-gas DIN ISO 228
UNC	UNC-Gewinde ANSI-B 1.1 UNC thread ANSI-B 1.1 Filetage UNC ANSI-B 1.1 UNC-passo grosso ANSI-B 1.1
UNF	UNF-Gewinde ANSI-B 1.1 UNF thread ANSI-B 1.1 Filetage UNF ANSI-B 1.1 UNF-passo fine ANSI-B 1.1
Typ N	Für gut spanbare Werkstoffe bis 800 N/mm ² For well chipping materials up to 800 N/mm ² Aciers mi durs < 800 N/mm ² Per materiali vari fino a 800 N/mm ²
Typ VA	Für rostfreie Materialien und Stähle höherer Festigkeit For stainless materials and steels of higher tensile strength Pour matériaux inoxydables et aciers à haute résistance Per acciai inox e ad alta resistenza
Typ GG	Für Grauguss For cast iron Pour fontes grises Per ghise
Typ AL	Für Aluminium For aluminium Pour aluminium Per alluminio
Typ H	Für kurzspanende, harte Werkstoffe For short-chipping, hard materials Pour matériaux à copeaux courts et tenaces Per materiali a truciolo corto e duri
Typ UNI	Für universellen Einsatz For universal use Pour utilisation universelle Per uso universale
AG	Abgesetztes Gewinde Back tapered thread part Troncature arrière Rastremazione posteriore
SN	Schmiernuten Lubrication grooves Rainures de lubrification Gole di lubrificazione
ISO2 6H	Toleranzklasse ISO 2 6H Tolerance classe ISO 2 6H Classe de tolérance ISO 2 6H Tolleranza ISO2 6H

6HX	Toleranzklasse 6HX Tolerance classe 6HX Classe de tolérance 6HX Tolleranza 6 HX
2B	Toleranzklasse 2B Tolerance classe 2B Classe de tolérance 2B Tolleranza 2B
HSSE-PM	Pulverstahl Powder steel Acier fritté Acciaio sinterizzato
HSSE	Hochleistungsschnellarbeitsstahl High speed steel Acier rapide Acciaio super rapido
DIN 352	Baumaße nach DIN 352 Dimensions acc. DIN 352 Dimensions selon DIN 352 Dimensioni sec. DIN 352
DIN 371	Baumaße nach DIN 371 Dimensions acc. DIN 371 Dimensions selon DIN 371 Dimensioni sec. DIN 371
DIN 374	Baumaße nach DIN 374 Dimensions acc. DIN 374 Dimensions selon DIN 374 Dimensioni sec. DIN 374
DIN 376	Baumaße nach DIN 376 Dimensions acc. DIN 376 Dimensions selon DIN 376 Dimensioni sec. DIN 376
DIN 2174	Baumaße nach DIN 2174 Dimensions acc. DIN 2174 Dimensions selon DIN 2174 Dimensioni sec. DIN 2174
DIN 2184-1	Baumaße nach DIN 2184-1 Dimensions acc. DIN 2184-1 Dimensions selon DIN 2184-1 Dimensioni sec. DIN 2184-1
DIN 5156	Baumaße nach DIN 5156 Dimensions acc. DIN 5156 Dimensions selon DIN 5156 Dimensioni sec. DIN 5156
55°	Flankenwinkel 55 Grad Flank angle 55 degree Angle de flanc 55 degrés Profilio a 55°
60°	Flankenwinkel 60 Grad Flank angle 60 degree Angle de flanc 60 degrés Profilio a 60°
DIN 13	Metrisches ISO-Gewinde nach DIN 13 Metric ISO-thread according to DIN 13 Filetage métrique selon DIN 13 Filettatura Metrica ISO secondo DIN 13
DIN ISO 228	Rohrgewinde nach DIN ISO 228 Pipe threads according to DIN ISO 228 Filetage pour tubes de Gaz selon DIN ISO 228 Filettatura Gas secondo DIN ISO 228

ANSI B 1.1	Unified-Gewinde nach ANSI B1.1 Unified threads according to ANSI B1.1 Filetage pas américains selon ANSI B 1.1 Filettatura Unified secondo ANSI B1.1
B	Anschnittform B, 3,5–5 Gewindegänge Chamfer form B, 3,5–5 threads Forme d'entrée B, 3,5–5 filets Imbocco forma B, 3,5–5 filetti
C	Anschnittform C, 2–3 Gewindegänge Chamfer form C, 2–3 threads Forme d'entrée C, 2–3 filets Imbocco forma C, 2–3 filetti
15°	Drallwinkel 15 Grad Helix angle 15 degree Angle d'hélice 15 degrés Elica a 15°
40°	Drallwinkel 40 Grad Helix angle 40 degree Angle d'hélice 40 degrés Elica a 40°
45°	Drallwinkel 45 Grad Helix angle 45 degree Angle d'hélice 45 degrés Elica a 45°
≤ 1,5xD	Für Durchgangsgewinde For through hole threads Pour trous débouchants Per fori passanti
≤ 1,5xD	Für Grundlochgewinde ≤1,5xD For blind hole threads ≤1,5xD Pour trous borgnes ≤1,5xD Per fori ciechi ≤1,5xD
≤ 2,5xD	Für Grundlochgewinde ≤2,5xD For blind hole threads ≤2,5xD Pour trous borgnes ≤2,5xD Per fori ciechi ≤2,5xD
≤ 3xD	Für Grundlochgewinde ≤3xD For blind hole threads ≤3xD Pour trous borgnes ≤3xD Per fori ciechi ≤3xD
VP	Vaporisiert Steam treatment Vaporisé Vaporizzato
TiN	Titan-Nitrid Titanium nitride Nitrure de titane Nitruro di titanio
TiCN	Titan-Carbonitrid Titanium carbonitride Carbonitrure de titane Carbonitruro di Titanio

Allgemeine Geschäftsbedingungen Conditions générales de vente

General sales conditions Condizioni generali di vendita

1. Angebot und Auftrag

Unsere Angebote erfolgen freibleibend. Aufträge und mündliche Vereinbarungen haben nur Gültigkeit, wenn sie von uns schriftlich bestätigt sind. Die Einkaufs- und Geschäftsbedingungen unserer Abnehmer werden von uns nicht anerkannt, auch wenn wir nicht widersprochen haben.

2. Preise

Die Grundpreise in unseren jeweils gültigen Listen sind unverbindliche Preisempfehlungen ohne Mehrwertsteuer. Sie gelten ab Bad Homburg und schließen die Kosten für Verpackung, Fracht, Porto und Wertsicherung nicht ein. Es werden jeweils die am Tage der Lieferung gültigen Preise und Zuschläge berechnet.

3. Zahlungsbedingungen

Die Zahlung ist innerhalb von 30 Tagen nach Rechnungsdatum ohne Abzug oder innerhalb von 10 Tagen mit 2% Skonto zu leisten. Bei verspäteter Zahlung sind wir berechtigt, Verzugszinsen von 5 Prozentpunkten über dem jeweiligen Basiszinssatz zu verlangen. Wechselspesen gehen zu Lasten des Käufers.

4. Eigentumsvorbehalt

- a) Wir behalten uns das Eigentum an allen von uns gelieferten Waren bis zur Erfüllung sämtlicher Forderungen aus der Geschäftsverbindung vor. Bei laufender Rechnung gilt der Eigentumsvorbehalt für die zu sichernde Saldoforderung.
- b) Der Käufer tritt uns im Voraus alle Forderungen aus einem Weiterverkauf der Ware oder sonstigen Geschäften mit der Ware sicherungshalber ab. Wird unsere Ware zusammen mit anderer Ware verkauft, gilt die Abtretung der Forderung nur in Höhe des Wertes unserer Vorbehaltsware.
- c) Der Käufer ist zum Verkauf der Ware und zur Einziehung der abgetretenen Forderung ermächtigt. Wir werden die Forderung nicht einziehen, solange der Käufer seinen Zahlungsverpflichtungen nachkommt. Solange unsere Forderungen nicht erfüllt sind, hat der Käufer die eingezogenen Beträge gesondert aufzubewahren und an uns abzuführen. Auf Verlangen hat der Käufer uns die Drittschuldner der abgetretenen Forderungen und die Forderungshöhe bekanntzugeben, den Drittschuldnern die Abtretung anzuzeigen und uns die notwendigen Unterlagen herauszugeben.
- d) Bei Nichteinhaltung der Zahlungsbedingungen, bei Wechselprotesten und Nichteinlösung von Schecks erlöschen die Rechte des Käufers zur Veräußerung und zum Einzug der abgetretenen Kaufpreisforderung. Wir sind in diesem Falle berechtigt, die von uns gelieferte Ware in unseren Besitz zu nehmen. Ein Rücktritt vom Vertrag ist darin nur zu erblicken, wenn wir dies ausdrücklich erklären. Alle Kosten einer Rücknahme gehen zu Lasten des Käufers. Von eventuellen Pfändungen sind wir unter Bekanntgabe des Pfandgläubigers sofort zu unterrichten. Interventionskosten gehen zu Lasten des Käufers.
- e) Auf Verlangen des Käufers geben wir voll bezahltes Liefergut nach unserer Wahl frei, wenn der Wert der uns gegebenen Sicherheit unsere Forderungen um mehr als 20% übersteigt.

5. Lieferung

Lieferzeiten werden so zuverlässig wie möglich eingehalten, sind jedoch nicht verbindlich.

6. Versand

Der Versand erfolgt auf Gefahr des Käufers. Die Verpackung wird zu Selbstkosten berechnet. Wenn vom Käufer gewünscht, kann die leere Verpackung nach Gebrauch zurückgegeben werden. Die Kosten für den Rücktransport trägt der Käufer.

7. Sachmängel

Mängelansprüche bestehen nicht bei ungeeigneter oder unsachgemäßer Verwendung, fehlerhafter Montage bzw. Inbetriebsetzung, natürlicher Abnutzung, fehlerhafter oder nachlässiger Behandlung u.ä..

8. Haftung

Für Schäden – gleich aus welchem Rechtsgrund – haftet der Verkäufer nur bei Vorsatz, grober Fahrlässigkeit, schuldhafter Verletzung von Leben, Körper, Gesundheit und in sonstigen Fällen zwingender Haftung wie z.B. nach dem Produkthaftungsgesetz.

9. Verjährung

Sachmängelansprüche und alle sonstigen Ansprüche des Käufers – aus welchem Rechtsgrund auch immer – verjähren in 12 Monaten, soweit nicht rechtlich zwingend längere Fristen gelten.

10. Rücknahme

Zur Rücknahme bestellter und richtig gelieferter, mangelfreier Ware sind wir nicht verpflichtet.

Erklären wir uns im Einzelfall schriftlich mit der Rücknahme einverstanden, berechnen wir pauschal 20% des Netto-Verkaufspreises, mindestens jedoch EUR 15,00 zzgl. MwSt als Wiedereinlagerungs- bzw. Warenrücknahmekosten.

Sonderanfertigungen oder speziell beschriftete oder gekennzeichnete Artikel sind von einer Rücknahme ausgeschlossen.

11. Erfüllungsort, Gerichtsstand, Allgemeines

Für Lieferung und Zahlung ist Bad Homburg Erfüllungsort. Gerichtsstand ist Frankfurt am Main. Für das Rechtsverhältnis gilt deutsches Recht. Die Unwirksamkeit einzelner Bestimmungen hat auf die Gültigkeit der übrigen Bestimmungen keinen Einfluß.

WEXO® Präzisionswerkzeuge GmbH

Siemensstraße 13

61352 Bad Homburg

For further languages please visit our website: www.wexo.com

Pour d'autres langues visitez notre site: www.wexo.com

Per altre lingue, visitate: www.wexo.com

Besuchen Sie uns auch im Internet
Visit us also on our website
Visitez aussi notre site
Visitate il nostro sito Internet

■ **WWW.WEXO.COM**

